



Systems, methods and apparatus for quiescence of autonomic systems with self action

Hinchey, M., & Sterritt, R. (2006). Systems, methods and apparatus for quiescence of autonomic systems with self action. (Patent No. 11/533855). <http://www.freepatentsonline.com/7899760.html>

[Link to publication record in Ulster University Research Portal](#)

Publication Status:

Published (in print/issue): 15/05/2006

Document Version

Publisher's PDF, also known as Version of record

General rights

Copyright for the publications made accessible via Ulster University's Research Portal is retained by the author(s) and / or other copyright owners and it is a condition of accessing these publications that users recognise and abide by the legal requirements associated with these rights.

Take down policy

The Research Portal is Ulster University's institutional repository that provides access to Ulster's research outputs. Every effort has been made to ensure that content in the Research Portal does not infringe any person's rights, or applicable UK laws. If you discover content in the Research Portal that you believe breaches copyright or violates any law, please contact pure-support@ulster.ac.uk.



US007899760B2

(12) **United States Patent**
Hinchey et al.

(10) **Patent No.:** **US 7,899,760 B2**
(45) **Date of Patent:** ***Mar. 1, 2011**

(54) **SYSTEMS, METHODS AND APPARATUS FOR QUIESCENCE OF AUTONOMIC SYSTEMS WITH SELF ACTION**

(52) **U.S. Cl.** **706/11**
(58) **Field of Classification Search** **706/11**
See application file for complete search history.

(75) Inventors: **Michael G. Hinchey**, Bowie, MD (US);
Roy Sterritt, Newtownabbey (IE)

(56) **References Cited**

(73) Assignee: **The United States of America as represented by the Administrator of the National Aeronautics and Space Administration**, Washington, DC (US)

U.S. PATENT DOCUMENTS

7,113,091 B2 * 9/2006 Script et al. 340/546
2006/0103540 A1 * 5/2006 Rutter et al. 340/628

(*) Notice: Subject to any disclaimer, the term of this patent is extended or adjusted under 35 U.S.C. 154(b) by 260 days.

This patent is subject to a terminal disclaimer.

OTHER PUBLICATIONS

Probst, J., Valentine, B., Axnix, C. and Kuehl, K. "Flexible configuration and concurrent upgrade for the IBM eServer z900", 0018-8646/2002, IBM.*
Sterritt, R. "Pulse monitoring: extending the health-check for the autonomic GRID", Aug. 2003, IEEE, pp. 433-440.*
Chakraborty, G. Murakami, M. Shiratori, N. and Noguchi, S. "A growing network that optimizes between undertraining and overtraining", IEEE ICNN, 1995, pp. 1116-1120.*

* cited by examiner

(21) Appl. No.: **11/533,855**

Primary Examiner — Michael B. Holmes

(22) Filed: **Sep. 21, 2006**

Assistant Examiner — Li-Wu Chang

(65) **Prior Publication Data**

US 2007/0073631 A1 Mar. 29, 2007

(74) *Attorney, Agent, or Firm* — Heather Goo

Related U.S. Application Data

(57) **ABSTRACT**

(60) Provisional application No. 60/811,149, filed on May 15, 2006.

Systems, methods and apparatus are provided in which an autonomic unit or element is quiesced. A quiesce component of an autonomic unit can cause the autonomic unit to self-destruct if a stay-alive reprieve signal is not received after a predetermined time.

(51) **Int. Cl.**
G06F 17/00 (2006.01)
G06F 17/20 (2006.01)

24 Claims, 29 Drawing Sheets

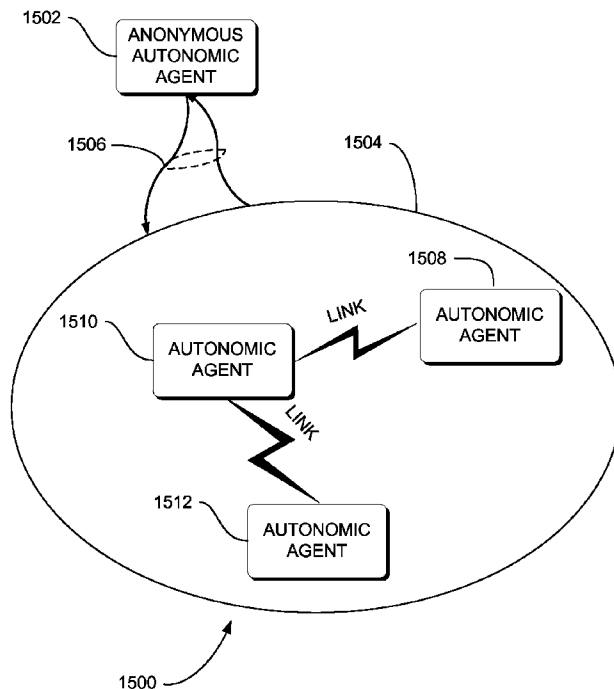

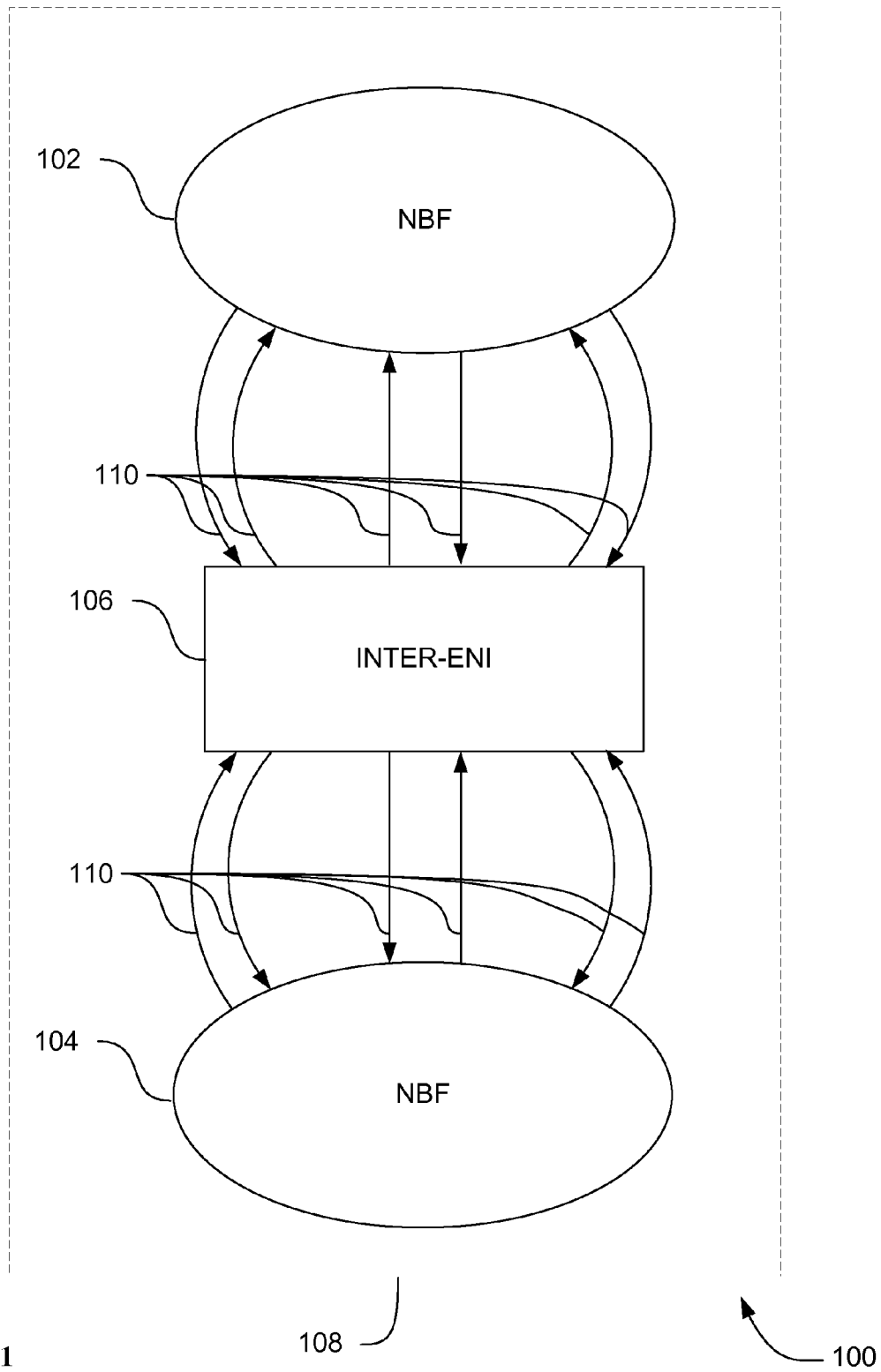

FIG. 1

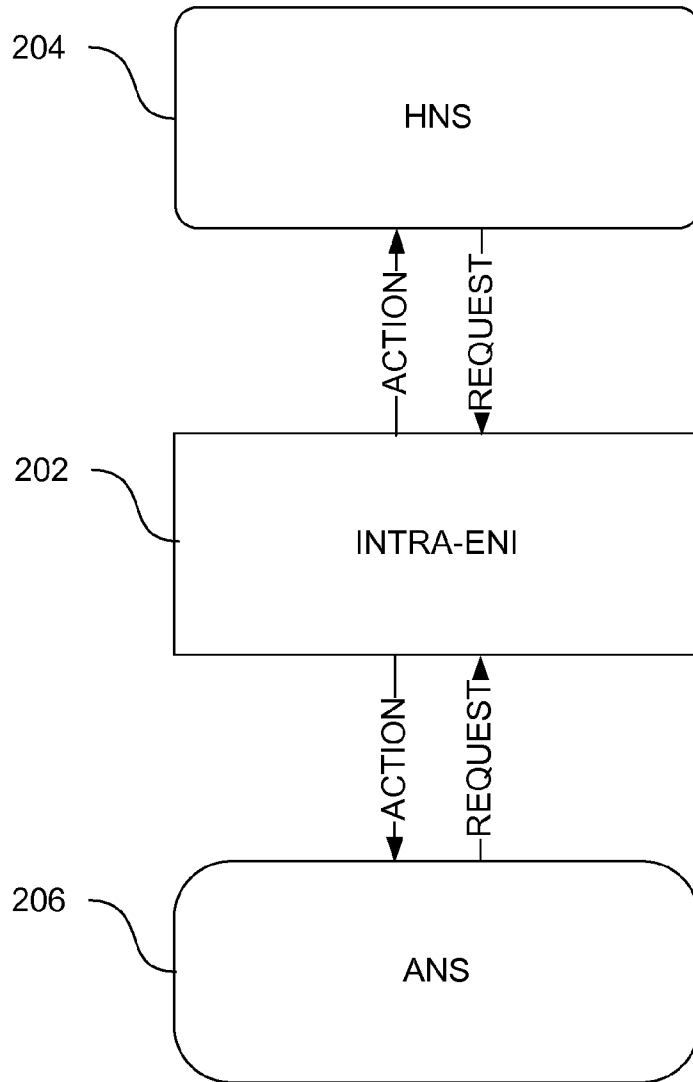

FIG. 2

200

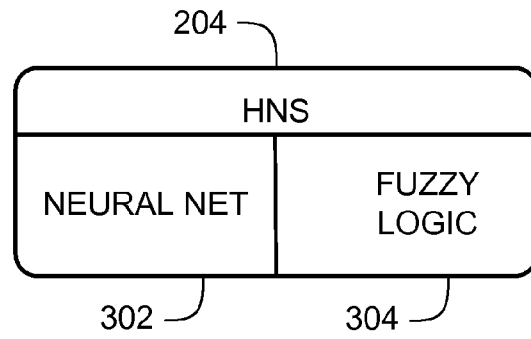
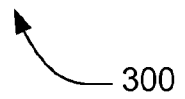

FIG. 3



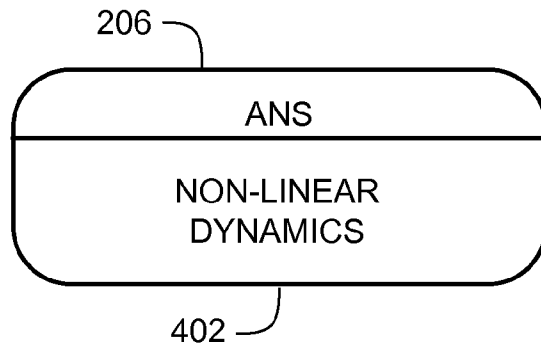
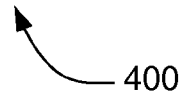
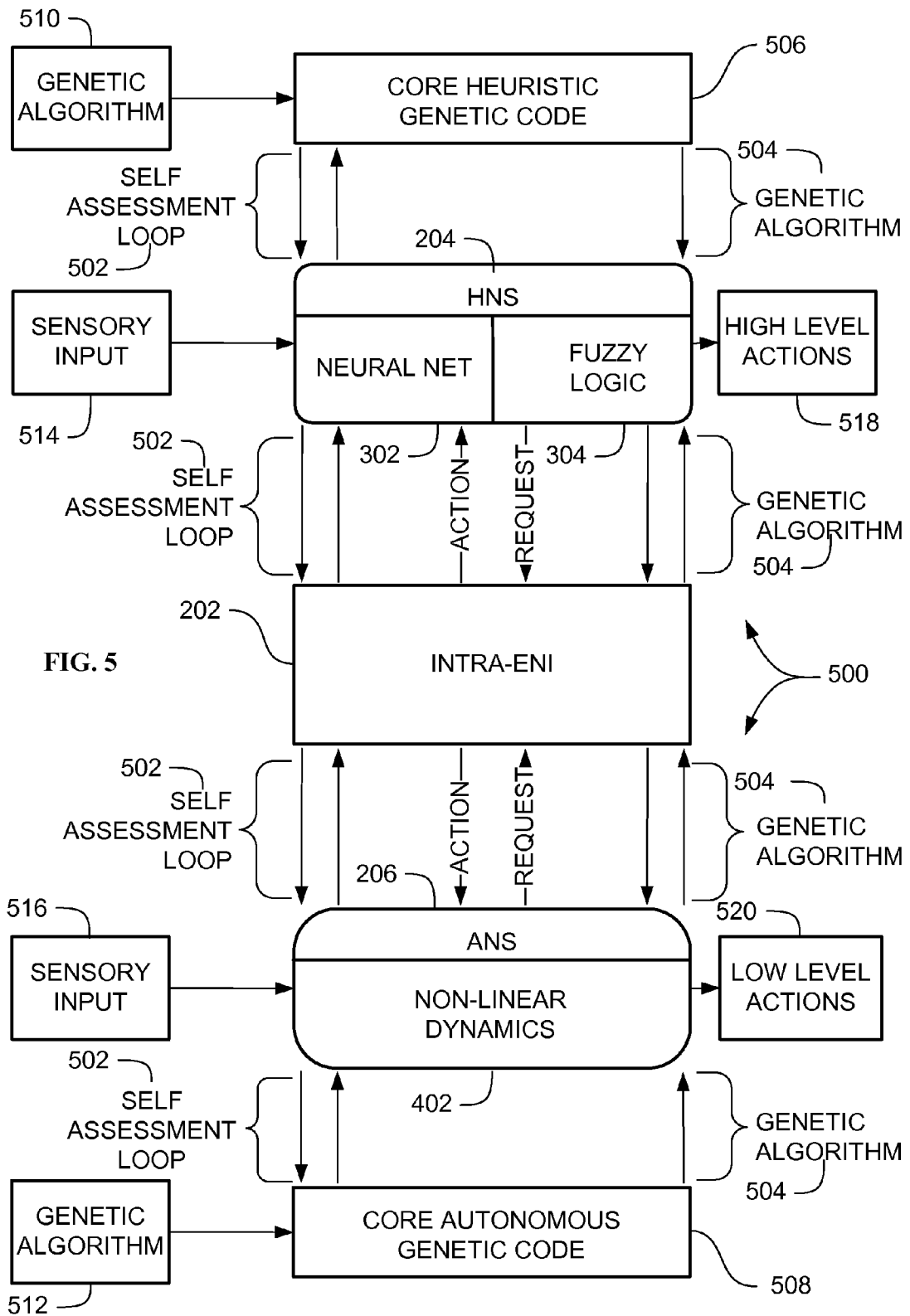
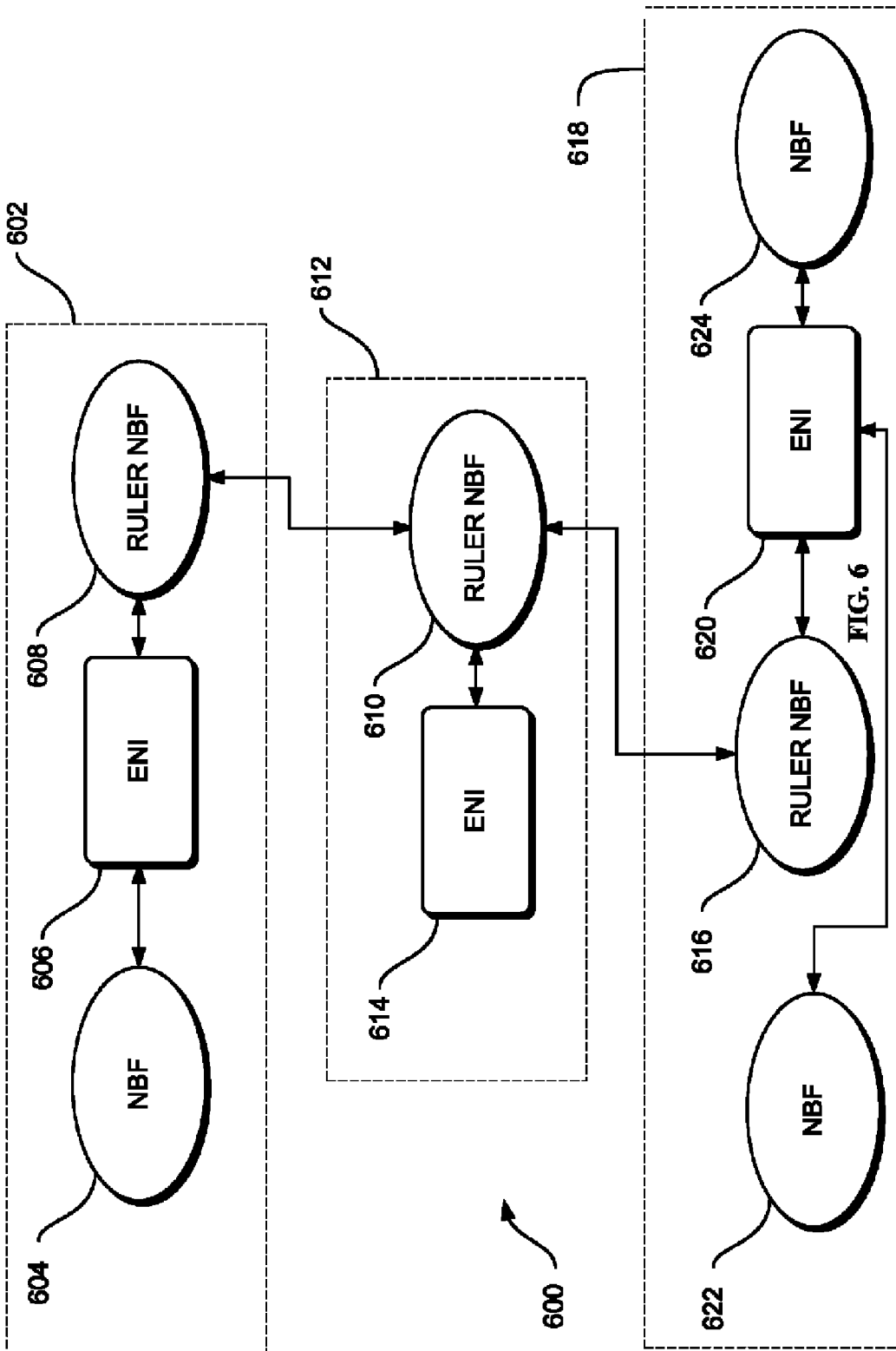

FIG. 4







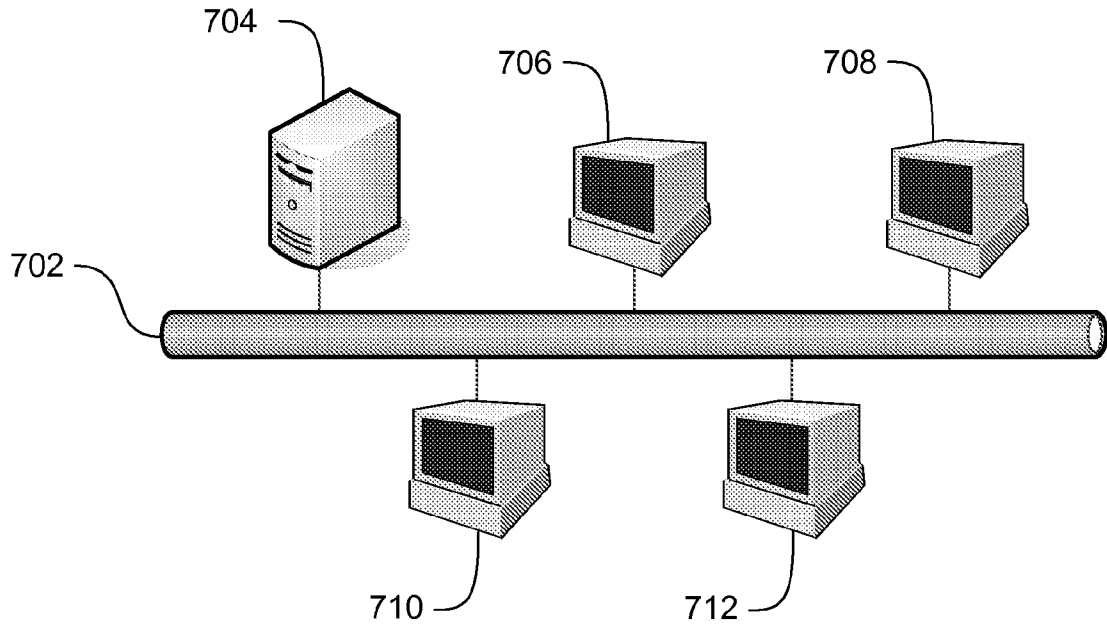
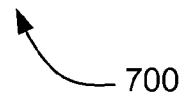

FIG. 7



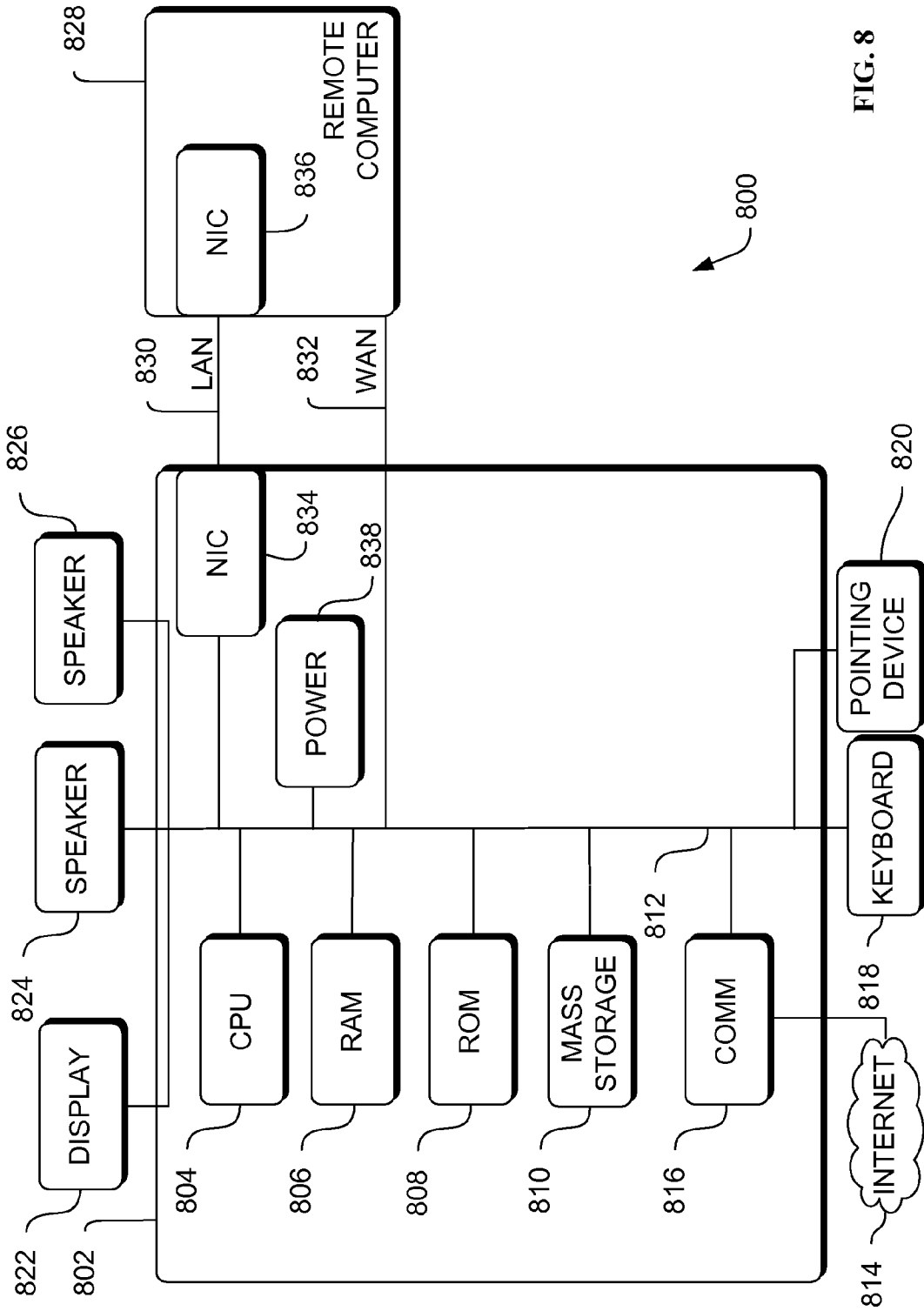

FIG. 8

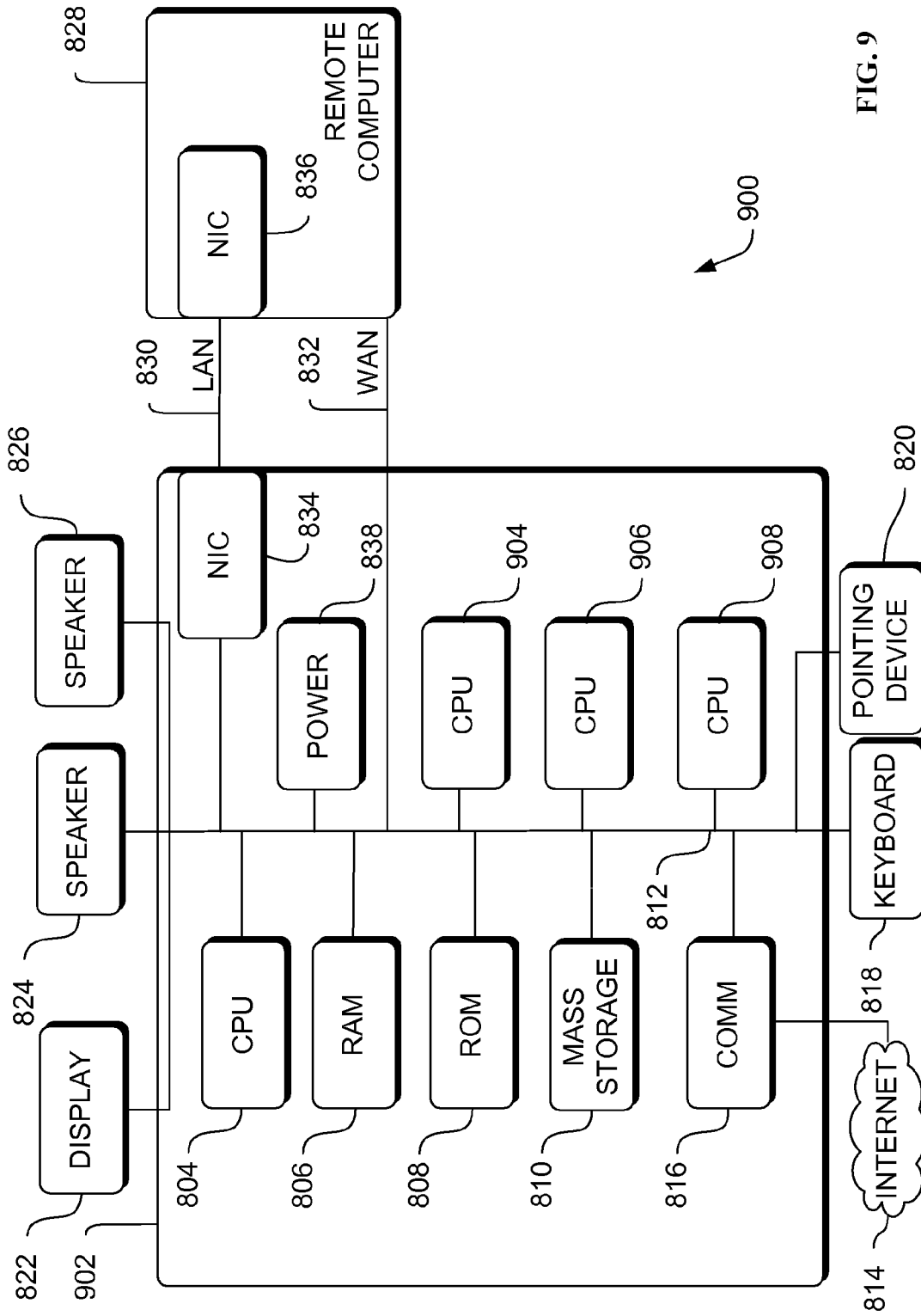

FIG. 9

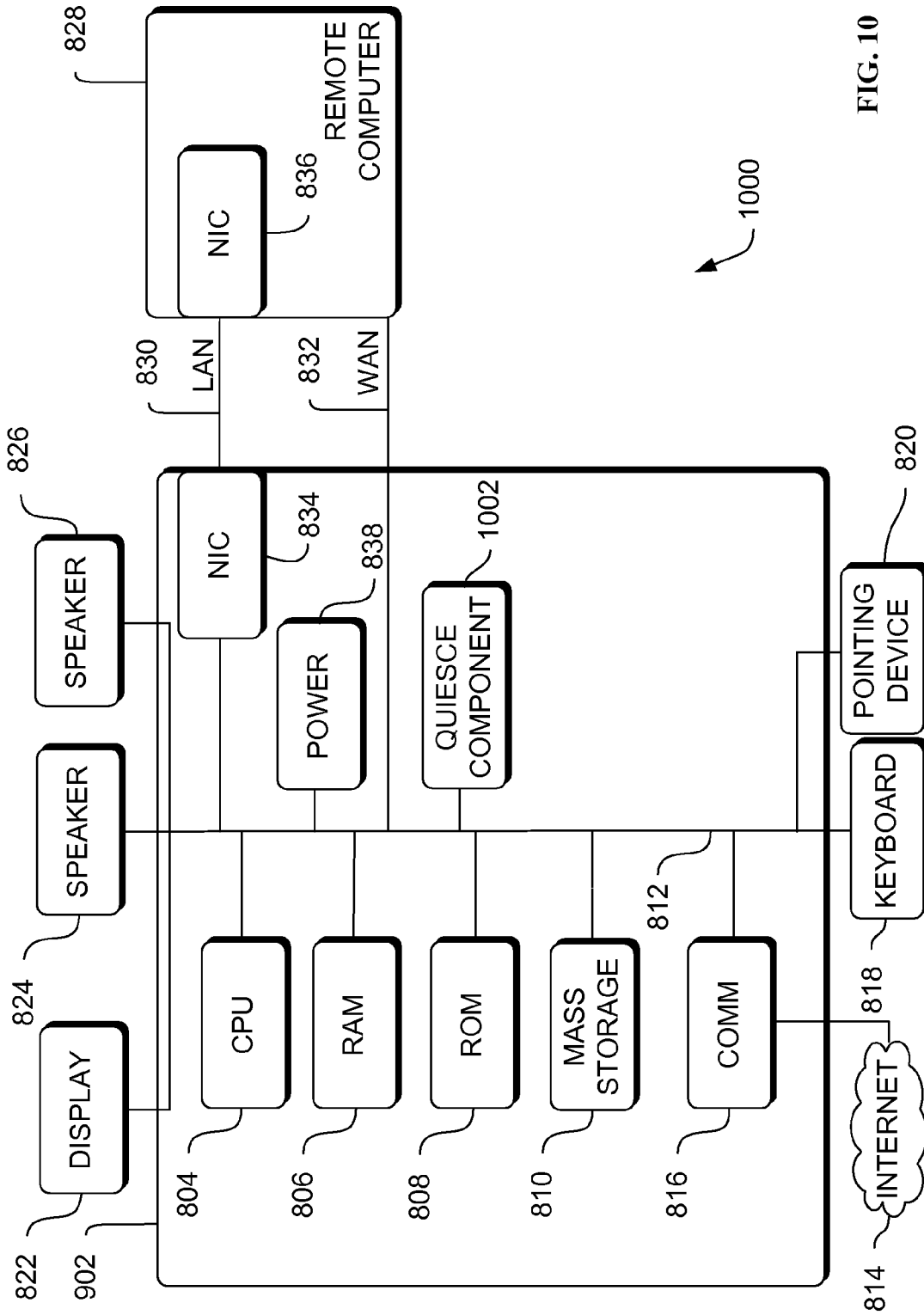

FIG. 10

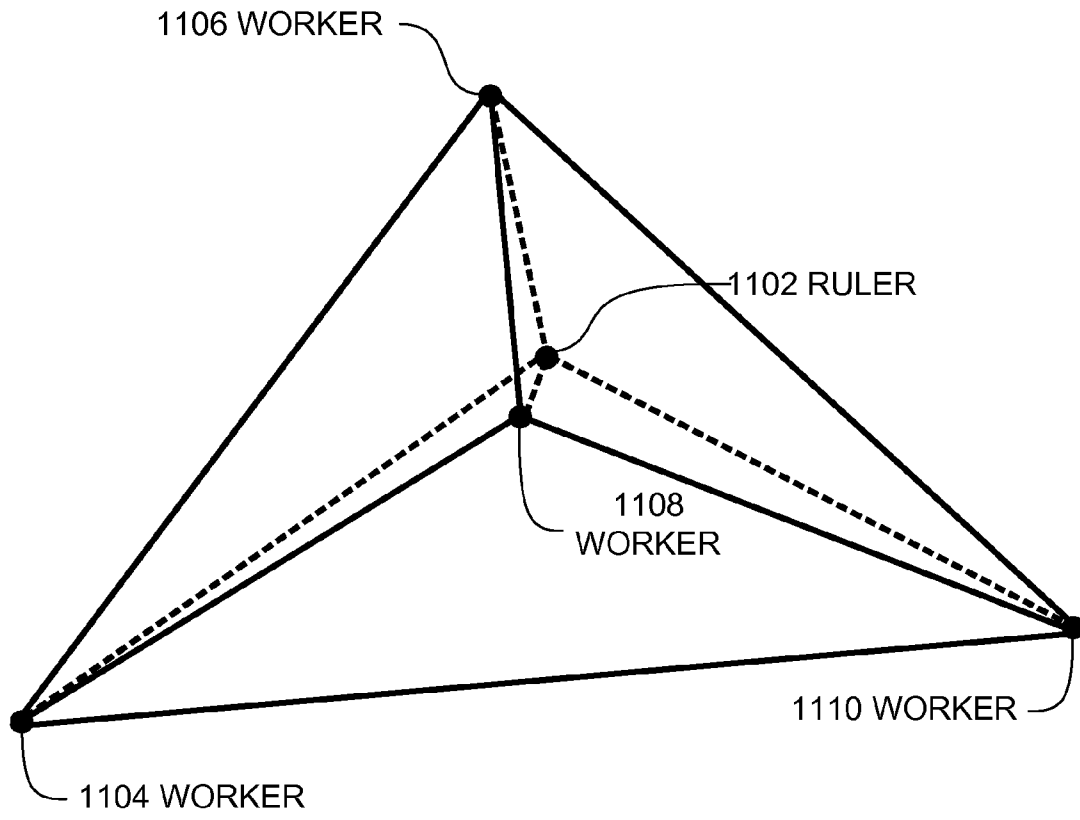
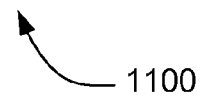

FIG. 11



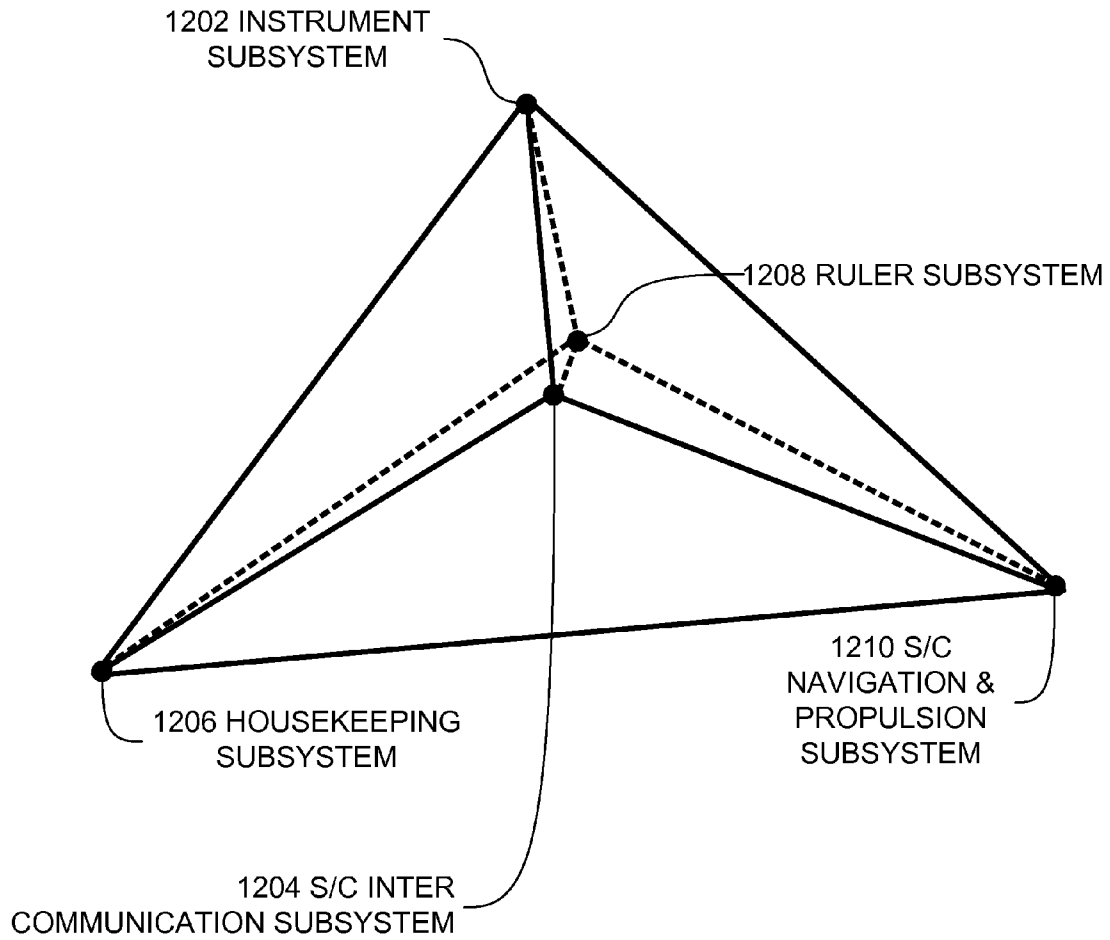

FIG. 12

1200

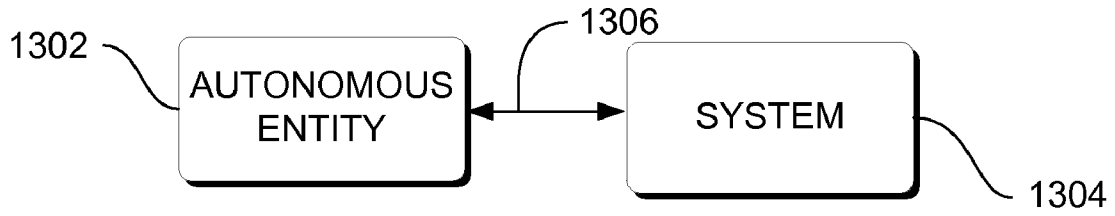
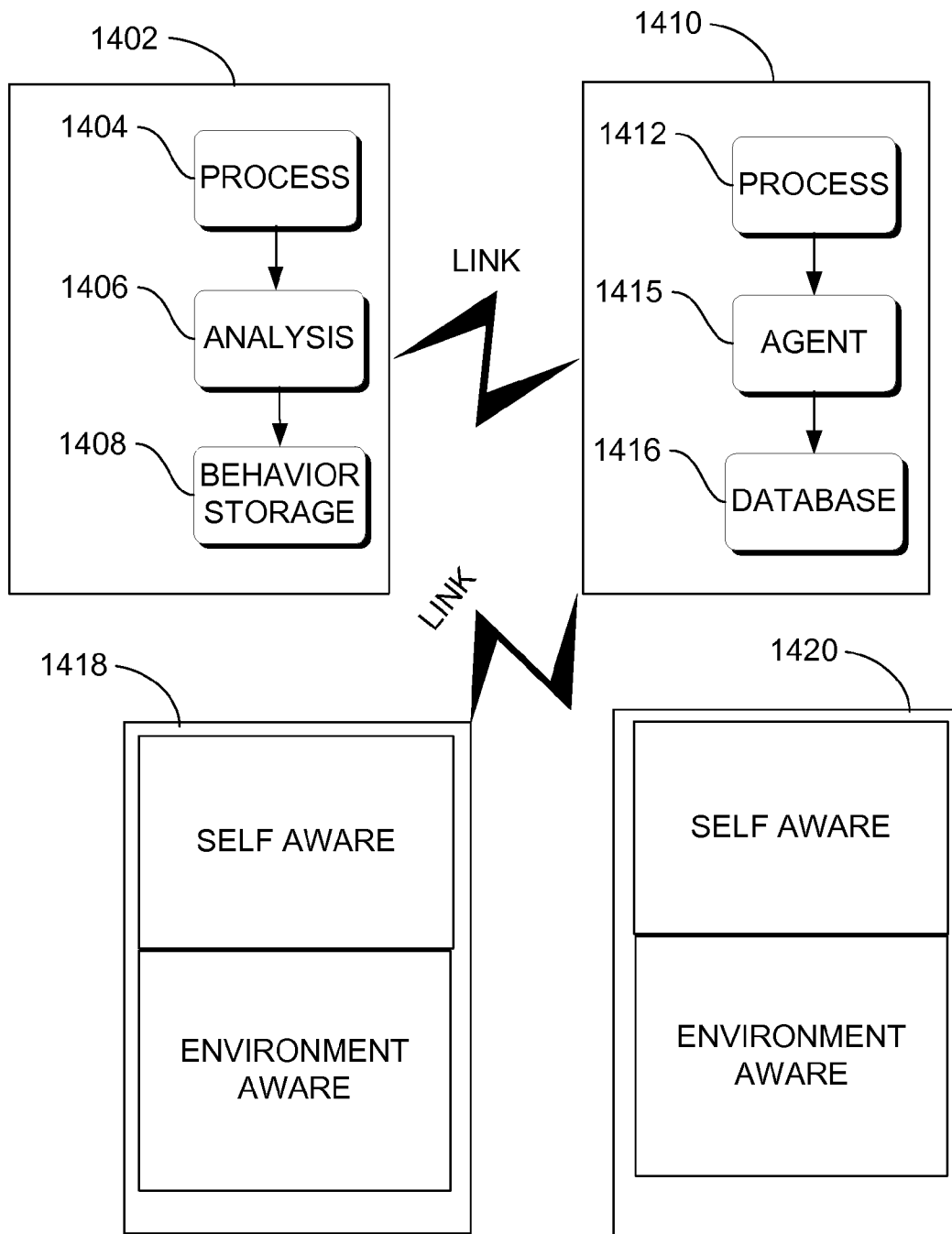

FIG. 13



1400 ↗

FIG. 14

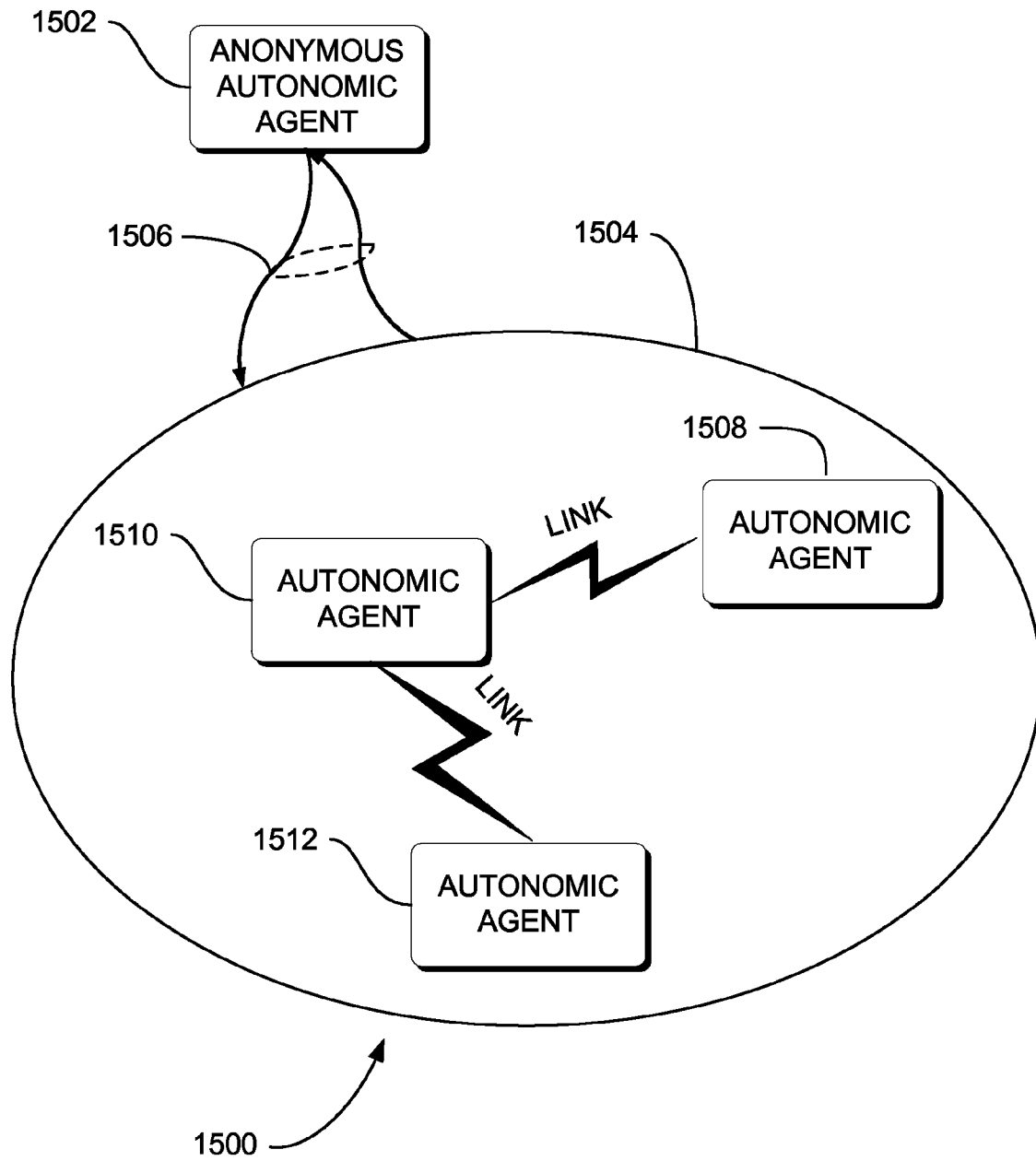

FIG. 15

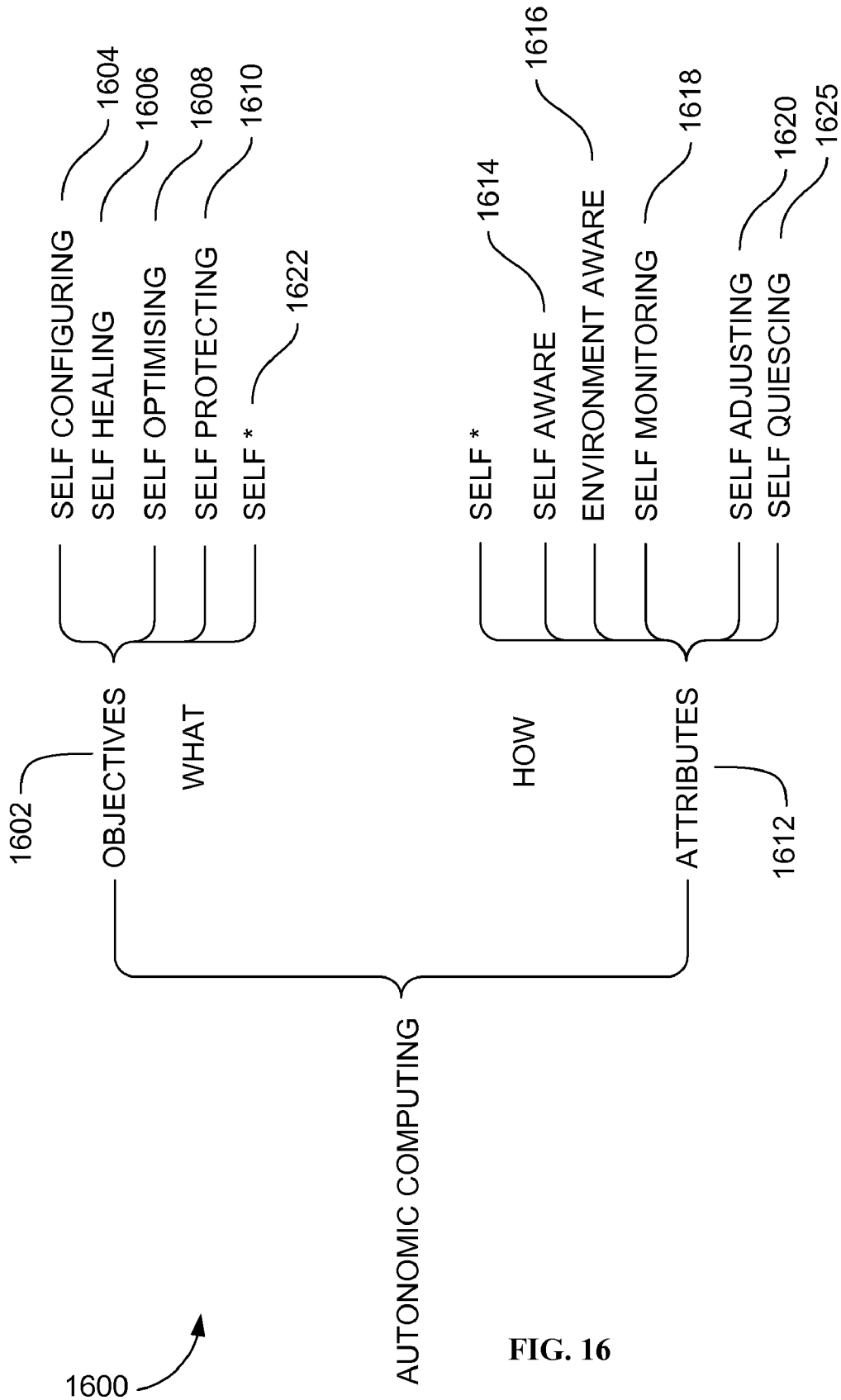
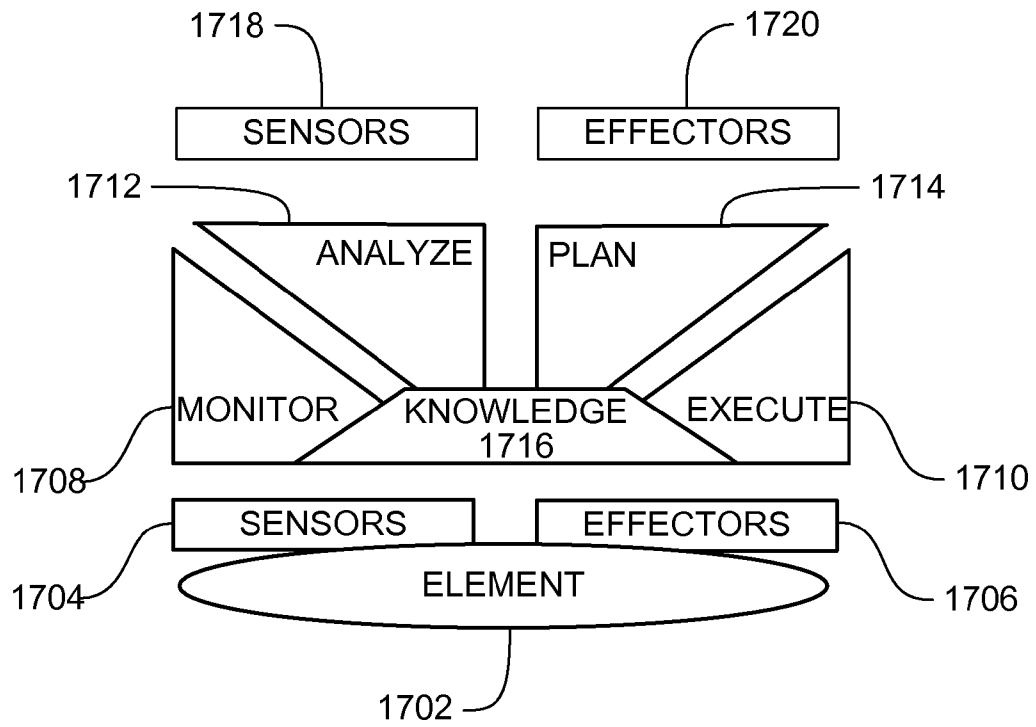
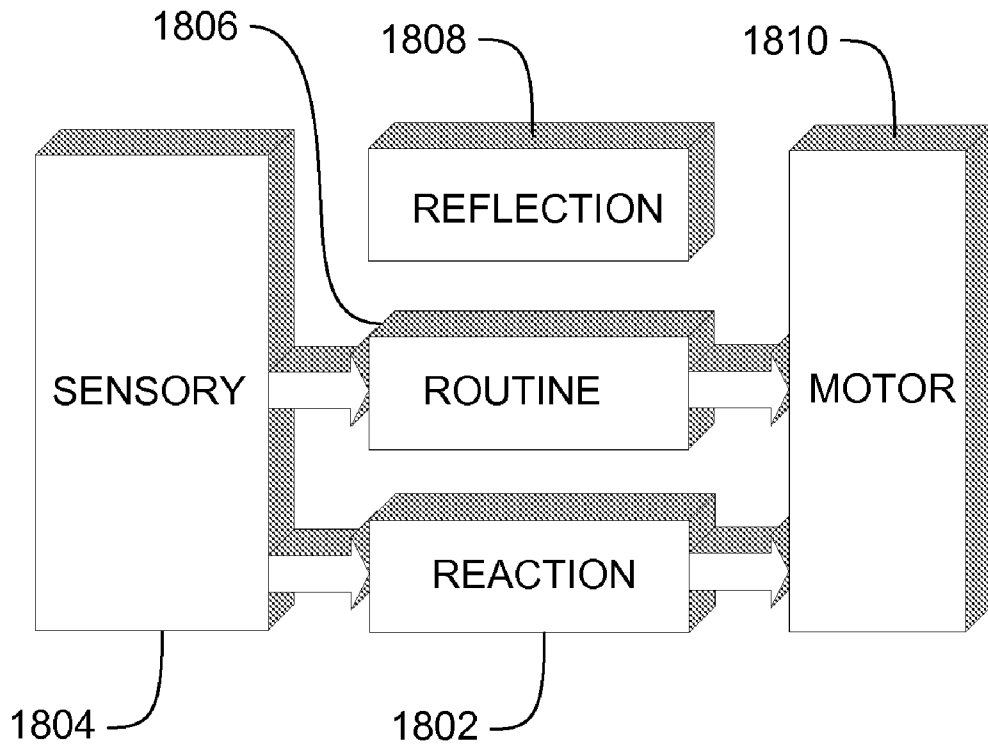

FIG. 16



1700 ↗

FIG. 17



1800 ↗

FIG. 18

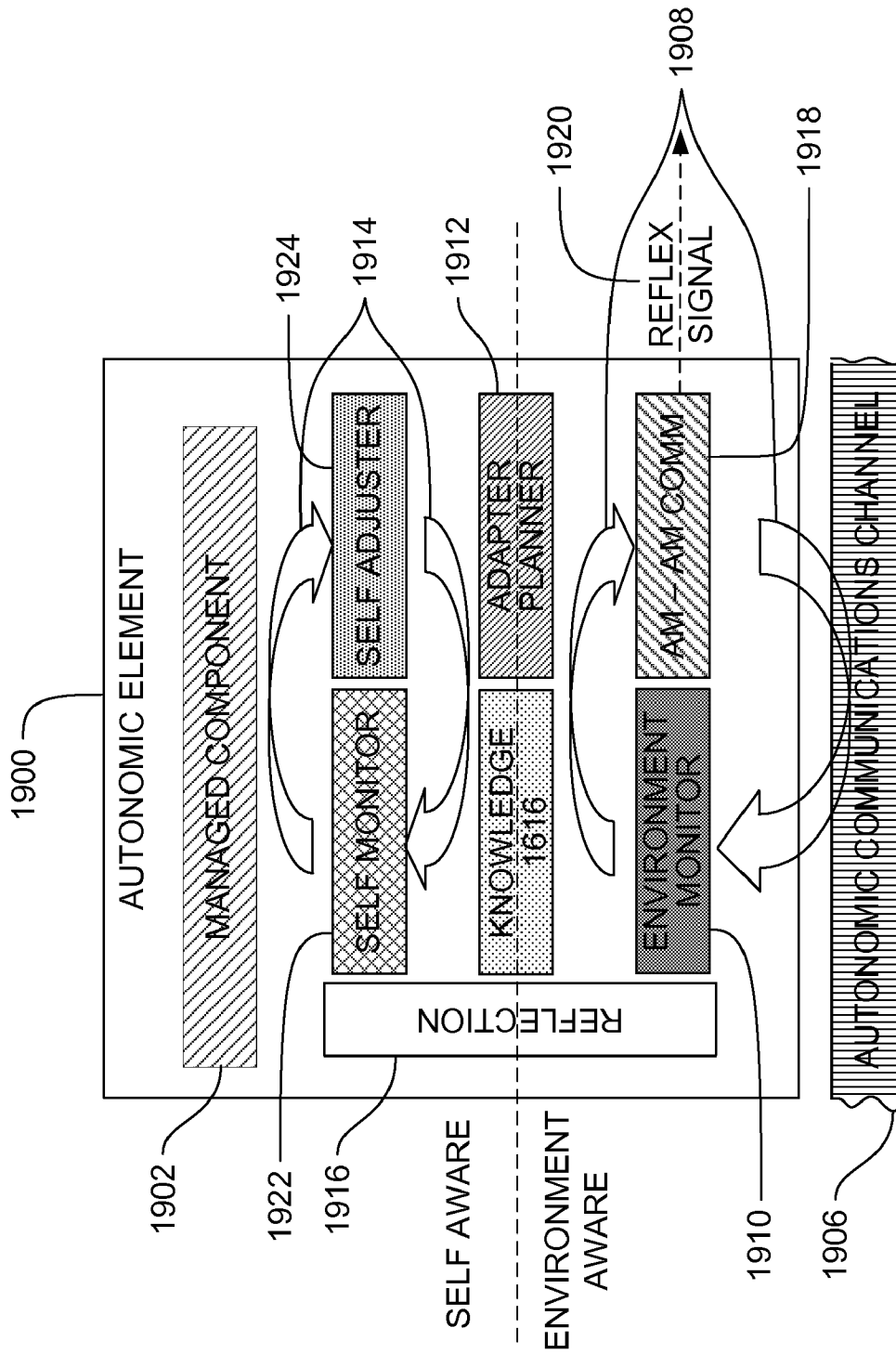

FIG. 19

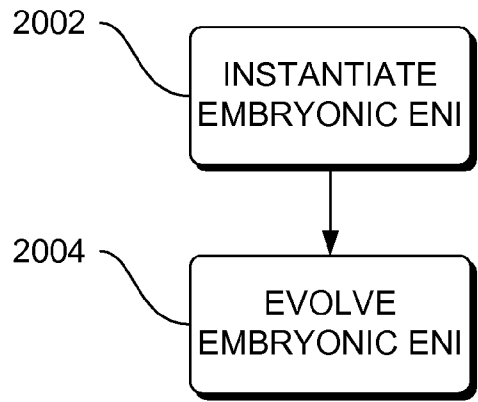

FIG. 20

2000

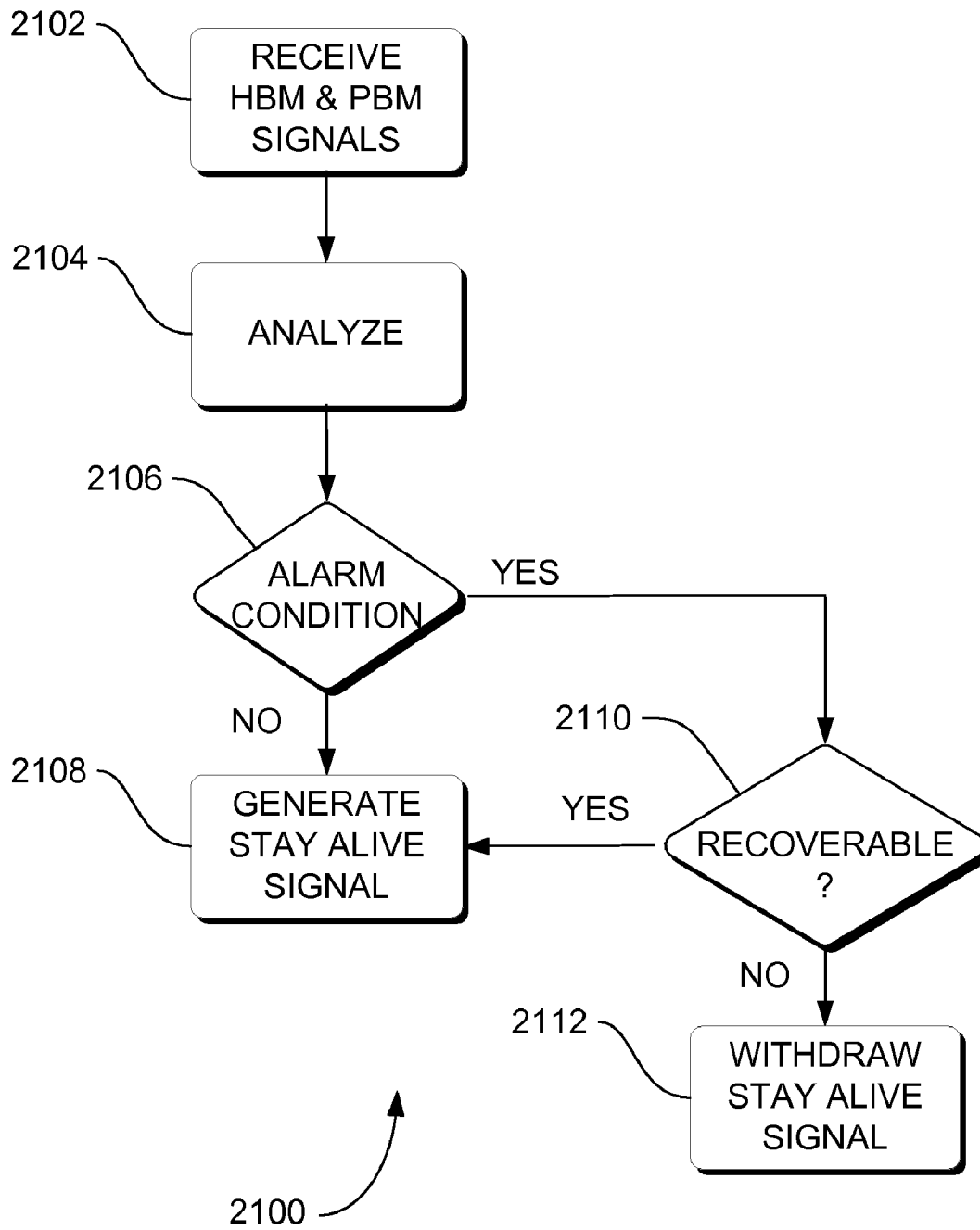

FIG. 21

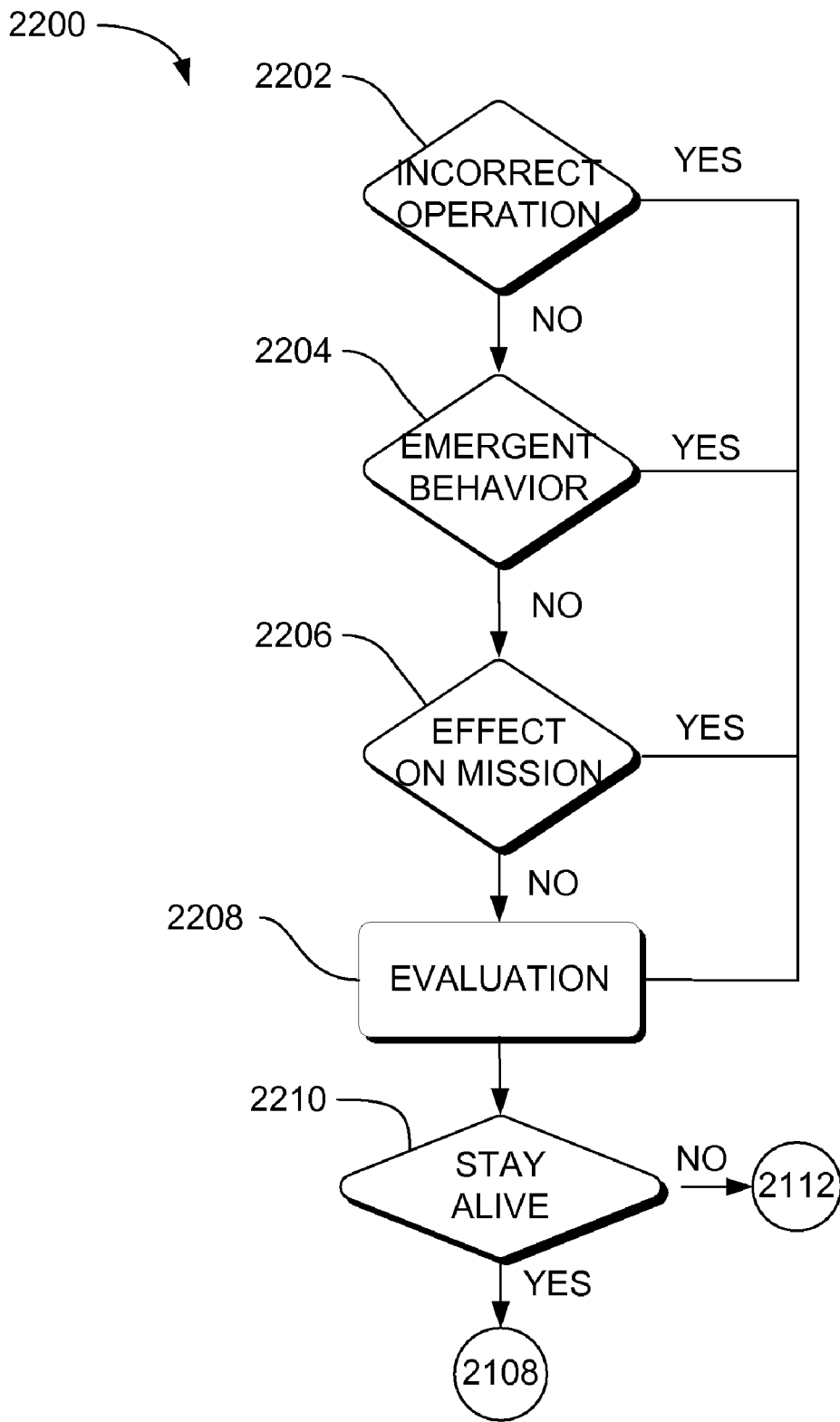

FIG. 22

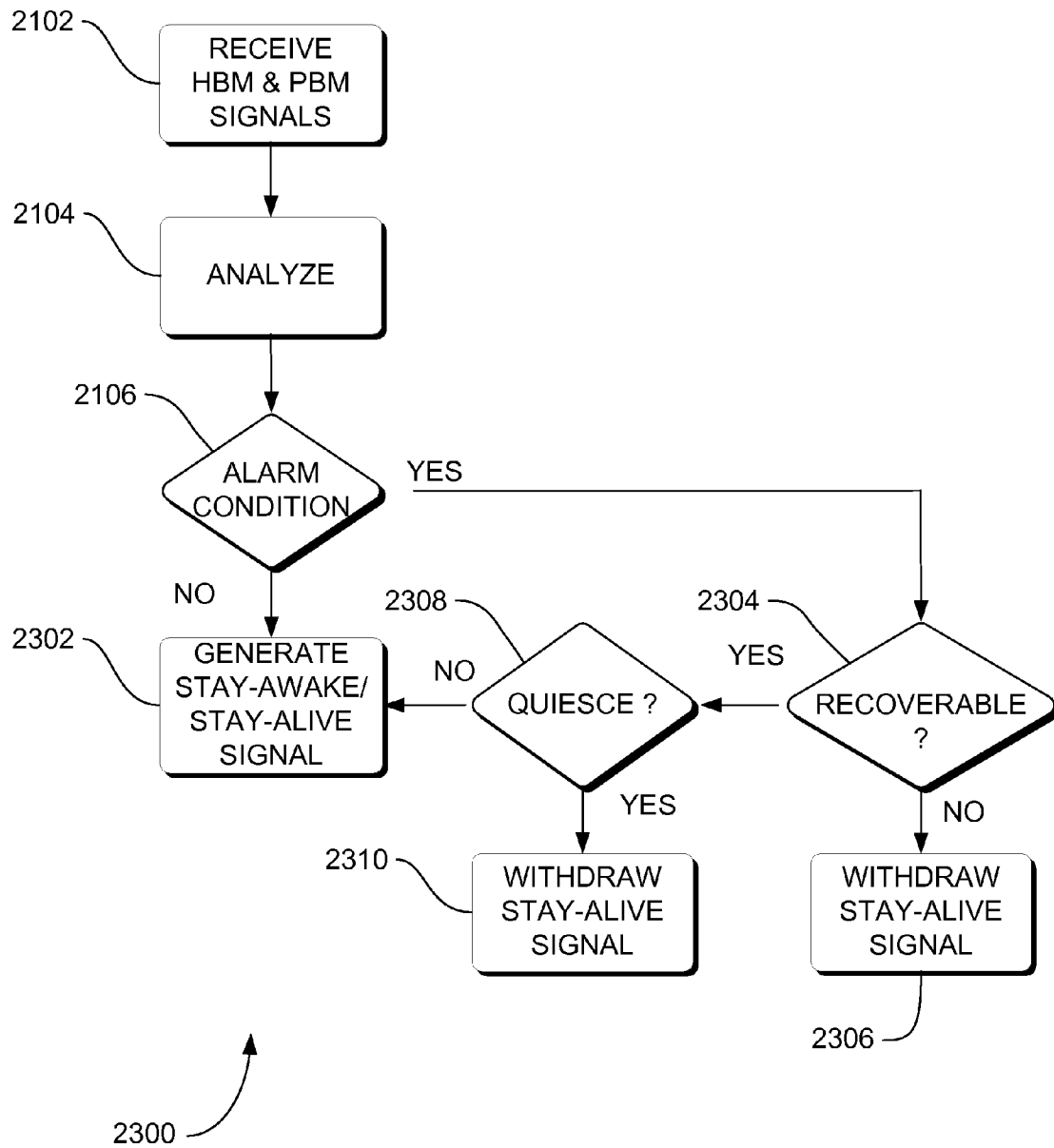

FIG. 23

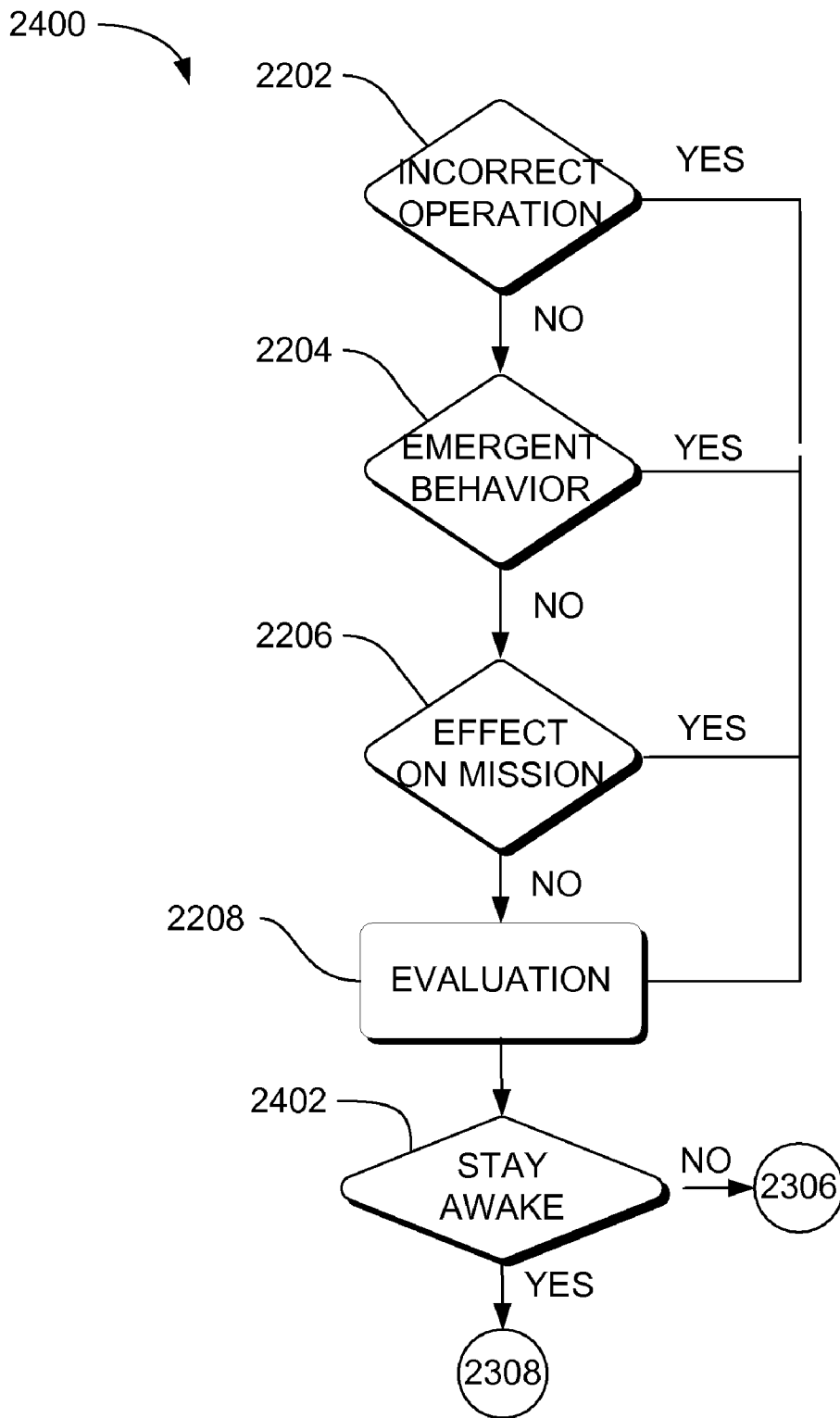

FIG. 24

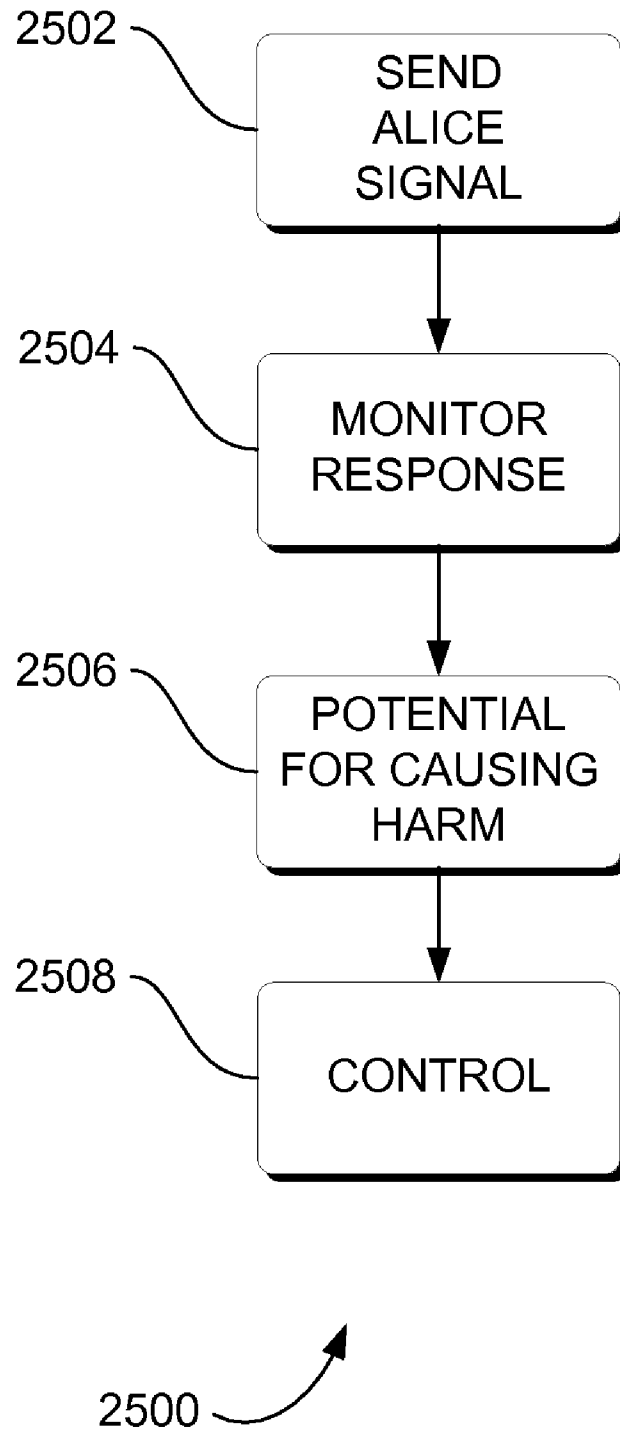

FIG. 25



FIG. 26

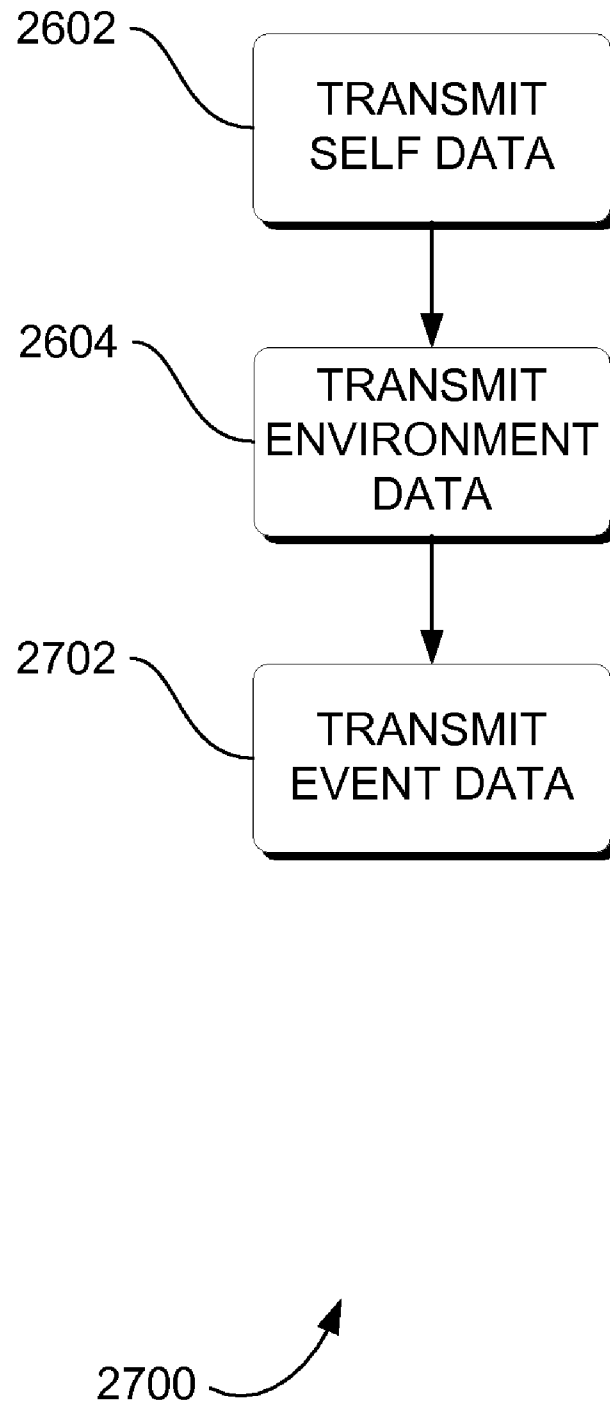

FIG. 27

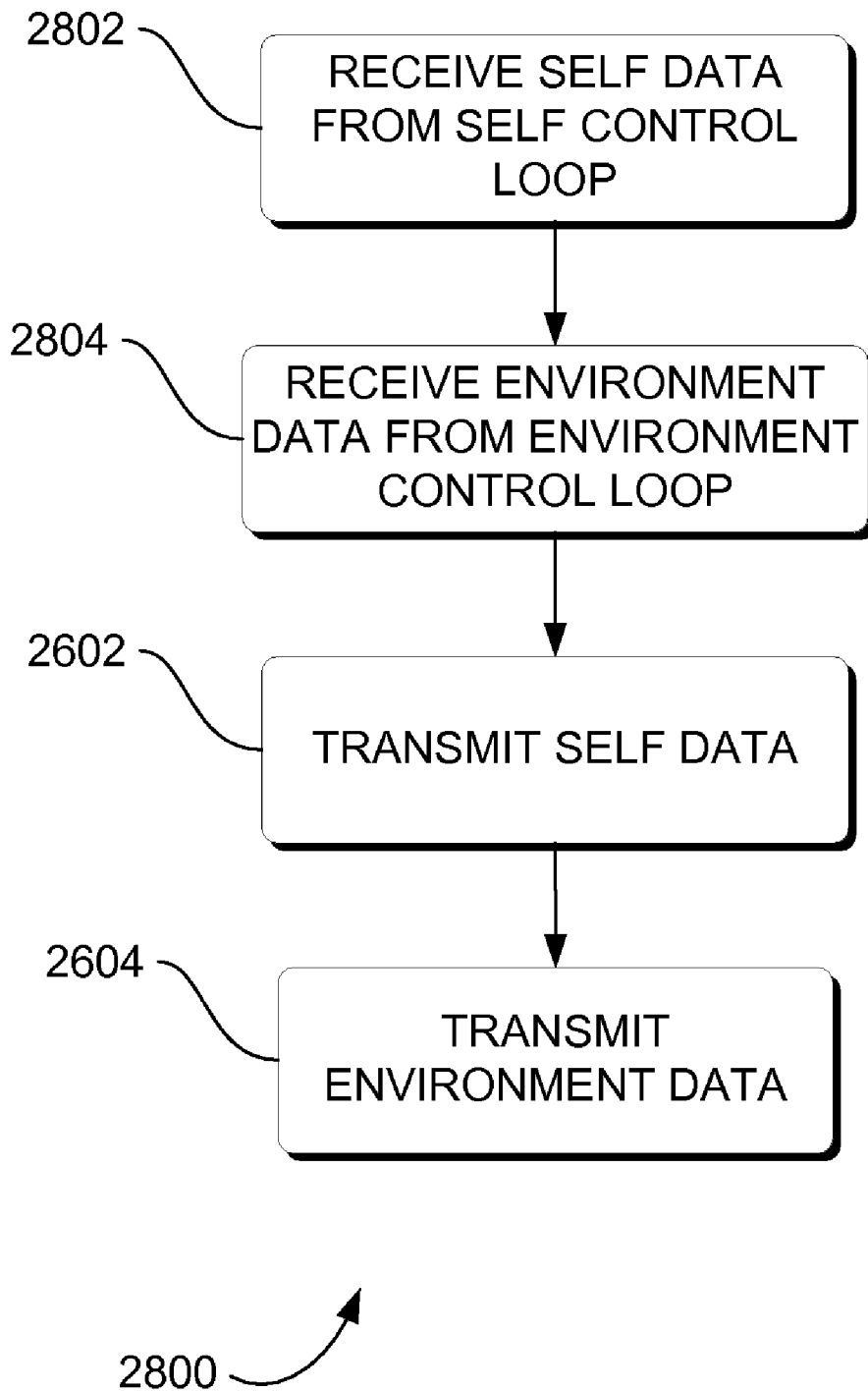

FIG. 28

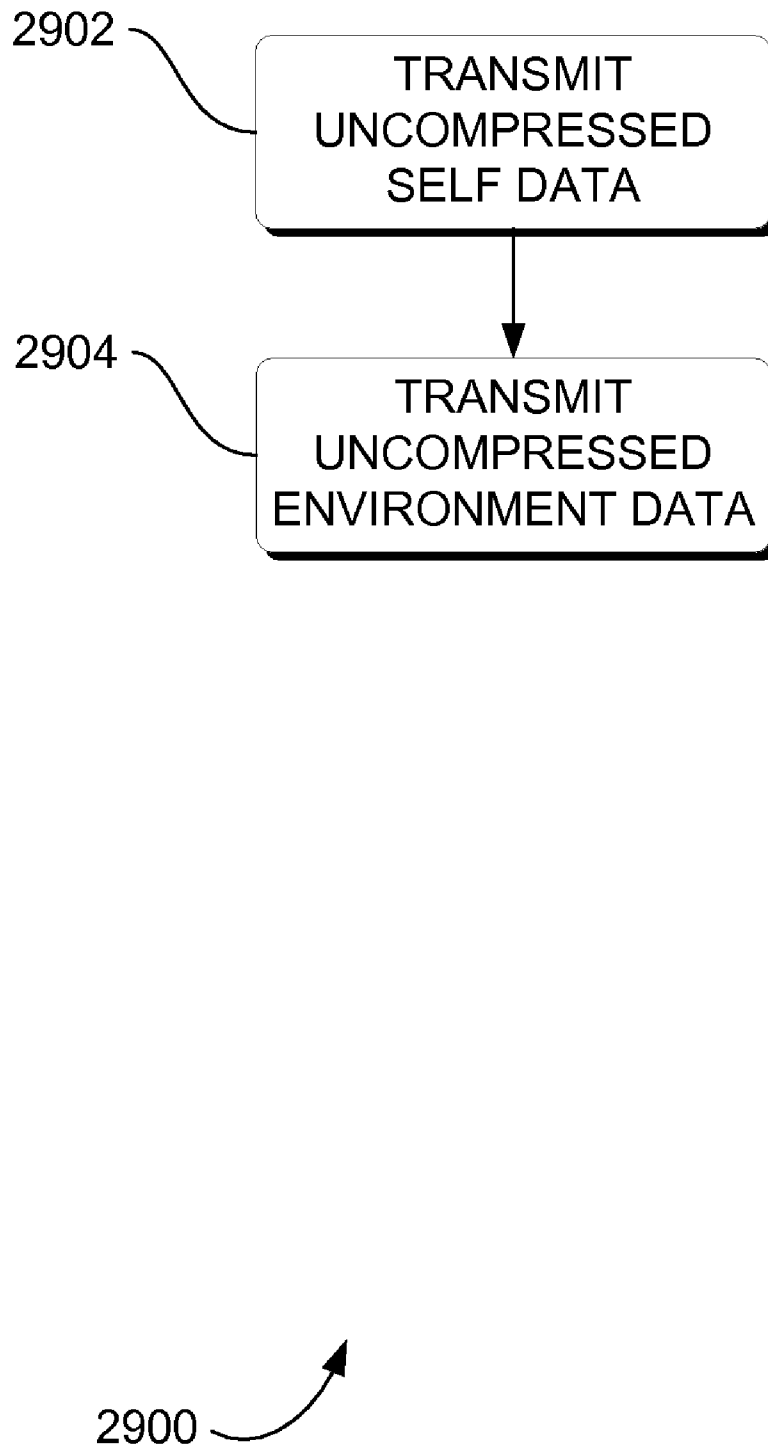

FIG. 29

SYSTEMS, METHODS AND APPARATUS FOR QUIESCENCE OF AUTONOMIC SYSTEMS WITH SELF ACTION

RELATED APPLICATIONS

This application claims the benefit of U.S. Provisional Application Ser. No. 60/811,149 filed May 15, 2006, under 35 U.S.C. 119(e). This application also claims, under 35 U.S.C. 120, the benefit of, and is a continuation-in-part to, co-pending U.S. application Ser. No. 11/426,853, filed Jun. 27, 2006, entitled "SYSTEMS, METHODS AND APPARATUS OF SELF-PROPERTIES FOR AN AUTONOMOUS AND AUTOMATIC COMPUTER ENVIRONMENT," which claims the benefit of U.S. Provisional Application Ser. No. 60/662,990 filed Jun. 27, 2005 under 35 U.S.C. 119(e), and which is a continuation-in-part to co-pending U.S. Original application Ser. No. 11/251,538, filed Sep. 29, 2005, entitled "SYSTEM AND METHOD FOR MANAGING AUTONOMOUS ENTITIES THROUGH APOPTOSIS," which claims the benefit of U.S. Provisional Application Ser. No. 60/634,459 filed Dec. 7, 2004 under 35 U.S.C. 119(e).

ORIGIN OF THE INVENTION

The invention described herein was made by an employee of the United States Government and may be manufactured and used by or for the Government of the United States of America for governmental purposes without the payment of any royalties thereon or therefor.

FIELD OF THE INVENTION

This invention relates generally to artificial intelligence and, more particularly, to architecture for collective interactions between autonomous entities.

BACKGROUND OF THE INVENTION

A synthetic neural system is an information processing paradigm that is inspired by the way biological nervous systems, such as the brain, process information. Biological systems inspire system design in many other ways as well, for example reflex reaction and health signs, nature inspired systems (NIS), hive and swarm behavior, and fire flies. These synthetic systems provide an autonomous computing entity that can be arranged to manage complexity, continuous self-adjustment, adjustment to unpredictable conditions, and prevention and recovery for failures.

One key element is the general architecture of the synthetic neural system. A synthetic neural system is composed of a large number of highly interconnected processing autonomic elements that are analogous to neurons in a brain working in parallel to solve specific problems. Unlike general purpose brains, a synthetic neural system is typically configured for a specific application and sometimes for a limited duration.

In one application of autonomic elements, each of a number of spacecrafts could be a worker in an autonomous space mission. The space mission can be configured as an autonomous nanotechnology swarm (ANTS). Each spacecraft in an ANTS has a specialized mission, much like ants in an ant colony have a specialized mission. Yet, a heuristic neural system (HNS) architecture of each worker in an ANTS provides coordination and interaction between each HNS that yields performance of the aggregate of the ANTS that exceeds the performance of a group of generalist workers.

More specifically, subset neural basis functions (SNBFs) within a HNS can have a hierarchical interaction among themselves much as the workers do in the entire ANTS collective. Hence, although many activities of the spacecraft could be controlled by individual SNBFs, a ruler SNBF could coordinate all of the SNBFs to assure that spacecraft objectives are met. Additionally, to have redundancy for the mission, inactive workers and rulers may only participate if a member of their type is lost.

In some situations, the ANTS encounters a challenging situation. For example, in some instances, the operation of a particular autonomic spacecraft can be detrimental either to the autonomic spacecraft or to the mission.

For the reasons stated above, and for other reasons stated below, which will become apparent to those skilled in the art upon reading and understanding the present specification, there is a need in the art to reduce the possibility that an autonomic element will jeopardize the mission of the autonomic element.

BRIEF DESCRIPTION OF THE INVENTION

The above-mentioned shortcomings, disadvantages and problems are addressed herein, which will be understood by reading and studying the following specification.

In at least one embodiment of the invention, a method for managing a system based on functioning state and operating status of the system includes processing received signals from the system, which are indicative of the functioning state and the operating status, to obtain an analysis of the condition of the system, generating one or more stay-awake signals based on the functioning status and the operating state of the system, transmitting the stay-awake signal, transmitting self health/urgency data, and transmitting environment health/urgency data.

In still yet other embodiments, an autonomic element includes a self-monitor that is operable to receive information from sensors and is operable to monitor and analyze the sensor information and access a knowledge repository, a self-adjuster operably coupled to the self-monitor in a self-control loop, the self-adjuster operable to access the knowledge repository, the self-adjuster operable to transmit data to effectors, and the self-adjuster operable to plan and execute; an environment monitor that is operable to receive information from sensors and operable to monitor and analyze the sensor information and access the knowledge repository; and an autonomic manager communications component operably coupled to the environment monitor in an environment control loop, the autonomic manager communications component operable to access the knowledge repository, the autonomic manager communications component also operable to produce and transmit a pulse monitor signal, and the pulse monitor signal including a heart beat monitor signal and a reflex signal, the reflex signal including self health/urgency data and environment health/urgency data. In exemplary embodiments, for example, a computer-accessible medium in a first autonomic element has executable instructions of autonomic communication for directing a processor of the first autonomic element to perform receiving a quiesce instruction from a second autonomic element; and

invoking a function of a quiesce component of the first autonomic element, and then, if the first autonomic element does not receive a stay-alive reprieve signal after a predetermined period of time, the first autonomic element to self-destruct; or an autonomic element includes a self-monitor, a self-adjuster operably coupled to the self-monitor in a self control loop, an environment-monitor, an autonomic man-

ager communications component operably coupled to the environment-monitor in an environment control loop, and a quiescing component, operably coupled to the self-monitor where the quiescing component receives a quiescing instruction from another autonomic element and withdraws a stay-awake signal, and then, if the autonomic element does not receive a reprieve signal after a predetermined period of time, the autonomic element self-destructs; or a computer-accessible medium has executable instructions to construct an environment to satisfy increasingly demanding external requirements capable of directing a processor to perform instantiating a first embryonic evolvable neural interface; and evolving the first embryonic evolvable neural interface towards complex connectivity, wherein the evolvable neural interface receives one or more heart beat monitor signal, pulse monitor signal, and quiesce signals, wherein the evolvable neural interface generates one or more heart beat monitor signal, pulse monitor signal, and quiesce signals, and wherein the first evolvable neural interface receives a quiesce signal from a second evolvable neural interface, and then, if the first evolvable neural interface does not receive a stay-alive reprieve signal after a predetermined period of time, the first evolvable neural interface self-destructs; or a computer-accessible medium has executable instructions to protect an autonomic system when encountering one or more autonomic agent capable of directing a processor of an autonomic agent to perform sending a quiesce signal to the autonomic agent; monitoring the response of the autonomic agent to the quiesce signal; and determining the autonomic agent potential for causing harm to the autonomic system, and then, if the autonomic agent does not receive a stay-alive reprieve signal after a predetermined period of time, the autonomic agent self-destructs. In an exemplary method, a method for protecting an autonomic system when encountering one or more autonomic agents includes determining the potential harm of the one or more autonomic agent; sending a quiesce signal to the one or more autonomic agent; and monitoring the response of the one or more autonomic agent to the quiesce signal, and then, if the autonomic agent does not receive a stay-alive reprieve signal after a predetermined period of time, the autonomic agent self-destructs.

Systems, clients, servers, methods, and computer-readable media of varying scope are described herein. In addition to the aspects and advantages described in this summary, further aspects and advantages will become apparent by reference to the drawings and by reading the detailed description that follows.

BRIEF DESCRIPTION OF THE DRAWINGS

FIG. 1 is a block diagram that provides an overview of an evolvable synthetic neural system to manage collective interactions between autonomous entities, according to an embodiment of the invention;

FIG. 2 is a block diagram of a neural basis function of a worker, according to an embodiment;

FIG. 3 is a block diagram of a heuristic neural system, according to an embodiment;

FIG. 4 is a block diagram of an autonomous neural system, according to an embodiment;

FIG. 5 is a block diagram of a neural basis function of a worker, according to an embodiment;

FIG. 6 is a block diagram of a multiple level hierarchical evolvable synthetic neural system, according to an embodiment;

FIG. 7 is a block diagram of a conventional computer cluster environment in which different embodiments can be practiced;

FIG. 8 is a block diagram of a conventional hardware and operating environment in which different embodiments can be practiced;

FIG. 9 is a block diagram of a conventional multiprocessor hardware and operating environment in which different embodiments can be practiced;

FIG. 10 is a block diagram of a hardware and operating environment, which includes a quiesce component, according to an embodiment.

FIG. 11 is a diagram of a three dimensional hierarchical evolvable synthetic neural system, according to an embodiment;

FIG. 12 is a diagram of a heuristic neural system, according to an embodiment, for a single instrument spacecraft to prospect asteroid belts;

FIG. 13 is a diagram of an autonomous entity managing a system, according to an embodiment;

FIG. 14 is a diagram of autonomous entities' interaction, according to an embodiment;

FIG. 15 is a block diagram of an autonomous entity management system, according to an embodiment;

FIG. 16 is a hierarchical chart of an autonomous entity management system, according to an embodiment;

FIG. 17 is a block diagram of an autonomic element, according to an embodiment;

FIG. 18 is a block diagram of autonomy and autonomicity at a high system level, according to an embodiment;

FIG. 19 is a block diagram of an architecture of an autonomic element, according to an embodiment, that includes reflection and reflex layers;

FIG. 20 is a flowchart of a method to construct an environment to satisfy increasingly demanding external requirements, according to an embodiment;

FIG. 21 is a flowchart of a method to construct an environment to satisfy increasingly demanding external requirements, according to an embodiment, where a ruler entity decides to withdraw or generate a stay alive signal;

FIG. 22 is a flowchart for a generating stay-alive signal when a warning condition occurs, according to an embodiment;

FIG. 23 is a flowchart of a method to construct an environment to satisfy increasingly demanding external requirements, according to an embodiment, where a ruler entity decides to withdraw or generate a stay-awake signal;

FIG. 24 is a flowchart for generating a stay-awake signal when a warning condition occurs, according to an embodiment;

FIG. 25 is a flowchart for interrogating an anonymous autonomic agent, according to an embodiment;

FIG. 26 is a flowchart of a method of autonomic communication by an autonomic element, according to an embodiment;

FIG. 27 is a flowchart of a method of autonomic communication by an autonomic element, according to an embodiment;

FIG. 28 is a flowchart of a method of autonomic communication by an autonomic element, according to an embodiment; and

FIG. 29 is a flowchart of a method of autonomic communication by an autonomic element, according to an embodiment.

DETAILED DESCRIPTION OF THE INVENTION

In the following detailed description, reference is made to the accompanying drawings that form a part hereof, and in

which is shown by way of illustration specific embodiments that may be practiced. These embodiments are described in sufficient detail to enable those skilled in the art to practice the embodiments, and it is to be understood that other embodiments may be utilized and that logical, mechanical, electrical and other changes may be made without departing from the scope of the embodiments. The following detailed description is, therefore, not to be taken in a limiting sense.

The detailed description is divided into six sections. In the first section, a system level overview is described. In the second section, apparatus are described. In the third section, hardware and the operating environments in conjunction with which embodiments may be practiced are described. In the fourth section, particular implementations are described. In the fifth section, embodiments of methods are described. Finally, in the sixth section, a conclusion of the detailed description is provided.

System Level Overview

FIG. 1 is a block diagram that provides an overview of an evolvable synthetic neural system to manage collective interactions between autonomous entities, according to an embodiment. System 100 may include a first plurality of neural basis functions (NBFs) 102 and 104. NBFs are the fundamental building block of system 100. In some embodiments of system 100, the plurality of NBFs includes more than the two NBFs 102 and 104 shown in FIG. 1. In some embodiments, system 100 includes only one NBF. One embodiment of a NBF is described below with reference to FIG. 2.

System 100 may also include a first inter-evolvable neural interface (ENI) 106 that is operably coupled to each of the first plurality of neural basis functions. The NBFs 102 and 104 may be highly integrated, and coupling between the NBFs through the ENI 106 may provide a three dimensional complexity. Thus, for example, when system 100 is implemented on microprocessors such as microprocessor 804 described below with reference to FIG. 8, system 100 may provide a synthetic neural system that reconciles the two dimensional nature of microprocessor technologies to the three dimensional nature of biological neural systems.

This embodiment of the inter-ENI 106 may be known as an inter-NBF ENI because the inter-ENI 106 is illustrated as being between or among the NBFs 102 and 104 at the same level within a hierarchy. System 100 shows only one level 108 of a hierarchy, although one skilled in the art will recognize that multiple hierarchies may be used within the scope of this invention.

System 100 may also operate autonomously. A system operates autonomously when it exhibits the properties of being self managing and self governing, often termed as autonomic, pervasive, sustainable, ubiquitous, biologically inspired, organic or with similar such terms. ENI 106 may adapt system 100 by instantiating new NBFs and ENIs and establishing operable communication paths 110 to the new NBFs and the ENIs to system 100. ENI 106 may also adapt system 100 by removing or disabling the operable communication paths 110 to the new NBFs and ENIs. The adapting, establishing, removing and disabling of the communication paths 110 may be performed autonomously. Thus, system 100 may satisfy the need for a synthetic neural system that performs significant tasks with complete autonomy.

System 100 may be capable of establishing and removing links to other similarly configured systems (not shown). Thus, the system 100 may be described as self-similar.

The system level overview of the operation of an embodiment is described in this section of the detailed description. Some embodiments may operate in a multi-processing, multi-threaded operating environment on a computer, such as computer 802 in FIG. 8.

While the system 100 is not limited to any particular NBF or ENI, for sake of clarity simplified NBFs and a simplified ENI are described.

Apparatus Embodiments

In the previous section, a system level overview of the operation of an embodiment is described. In this section, particular apparatus of such an embodiment are described by reference to a series of block diagrams. Describing the apparatus by reference to block diagrams enables one skilled in the art to develop programs, firmware, or hardware, including such instructions to implement the apparatus on suitable computers, executing the instructions from computer-readable media.

In some embodiments, apparatus 200-600 are implemented by a program executing on, or performed by firmware or hardware that is a part of a computer, such as computer 802 in FIG. 8.

FIG. 2 is a block diagram of a neural basis function (NBF) 200 of a worker according to an embodiment. NBF 200 is illustrated as a bi-level neural system because both high-level functions and low-level functions are performed by NBF 200.

NBF 200 may include an intra-evolvable neural interface (intra-ENI) 202. The ENI 202 may be operably coupled to a heuristic neural system (HNS) 204 and operably coupled to an autonomous neural system (ANS) 206. The HNS 204 may perform high-level functions and the ANS 206 may perform low-level functions that are often described as "motor functions" such as "motor" 1810 in FIG. 18 below. In NBF 200, the HNS 204 and the ANS 206 in aggregate may provide a function of a biological neural system. The intra-ENI 202 shown in FIG. 2 is an ENI that is wholly contained within an NBF, and is therefore prefixed with "intra."

The intra-ENI 202 may send action messages to and receive request messages from the HNS 204 and the ANS 206 during learning and task execution cycles, as well as during interfacing operations between the intra-ENI and the HNS 204 and the ANS 206 when the HNS 204 and the ANS 206 need to be modified as a result of other system failures or modification of objectives. NBF 200 is illustrated as a worker NBF because this NBF performs functions, but does not provide instructions commands to other NBFs.

FIG. 3 is a block diagram of a heuristic neural system 300 according to an embodiment.

The heuristic neural system (HNS) 300 may be composed of a neural net 302 for pattern recognition and a fuzzy logic package 304 to perform decisions based on recognitions. Taken together the neural net 302 and the fuzzy logic package 304 may form a basis for a higher level heuristic intelligence.

FIG. 4 is a block diagram of an autonomous neural system 400 according to an embodiment.

The autonomous neural system (ANS) 400 may include a non-linear dynamics simulation 402 that represents smart servo system behavior.

FIG. 5 is a block diagram of a neural basis function (NBF) 500 of a worker according to an embodiment. NBF 500 is shown as a bi-level neural system.

In some embodiments, NBF 500 may include a self assessment loop (SAL) 502 at each interface between autonomic components. Each SAL 502 may continuously gauge efficiency of operations of the combined HNS 204 and ANS 206.

The standards and criteria of the efficiency may be set or defined by objectives of the NBF **500**.

In some embodiments, NBF **500** may also include genetic algorithms (GA) **504** at each interface between autonomic components. The GAs **504** may modify the intra-ENI **202** to satisfy requirements of the SALs **502** during learning, task execution or impairment of other subsystems.

Similarly, the HNS **204** may have a SAL **502** interface and a GA **504** interface to a core heuristic genetic code (CHGC) **506**, and the ANS **206** may have a SAL **502** interface and a GA **504** interface to a core autonomic genetic code (CAGC) **508**. The CHGC **506** and CAGC **508** may allow modifications to a worker functionality in response to new objectives or injury. The CHGC **506** and the CAGC **508** autonomic elements may not be part of an operational neural system, but rather may store architectural constraints on the operating neural system for both parts of the bi-level system. The CHGC **506** and the CAGC **508** may both be modifiable depending on variations in sensory inputs via GAs **504**.

In some embodiments, the CHGC **506** and the CAGC **508** in conjunction with SALs **502** and GAs **504** may be generalized within this self similar neural system to reconfigure the relationship between NBFs as well as to permit the instantiation of new NBFs to increase the overall fitness of the neural system. Thus, NBF **500** may provide a form of evolution possible only over generations of BNF workers.

In some embodiments, NBF **500** may also include genetic algorithms **510** and **512** that provide process information to the CHGC **506** and the CAGC **508**, respectively. HNS **204** and ANS **206** may receive sensory input **514** and **516**, respectively, process the sensory input and generate high level actions **518** and low level actions **520**, respectively.

FIG. **6** is a block diagram of a multiple level hierarchical evolvable synthetic neural system (ESNS) **600** according to an embodiment.

The multiple level hierarchical ESNS **600** may include a first level of hierarchy **602** that includes a NBF **604** and inter-ENI **606** and a ruler NBF **608**. A ruler NBF, such as ruler NBF **608** may perform functions and also provide instructions commands to other subordinate NBFs.

The ruler NBF **608** of the first hierarchical level **602** is illustrated as being operably coupled to a ruler NBF **610** in a second hierarchical level **612**. Ruler NBF **610** may perform functions, receive instructions and commands from other ruler NBFs that are higher in the hierarchy of the ESNS **600** and also provide instructions commands to other subordinate NBFs.

The second hierarchical level **612** may also include an inter-ENI **614**. The second hierarchical level **612** of FIG. **6** shows an embodiment of an ESNS **600** having one NBF operably coupled to an ENI. The ruler NBF **610** of the second hierarchical level **612** may be operably coupled to a ruler NBF **616** in a third hierarchical level **618**.

The third hierarchical level **616** may also include an inter-ENI **620**. The third hierarchical level **616** of FIG. **6** shows an embodiment of an ESNS **600** having more than two NBFs (e.g. **616**, **622** and **624**) operably coupled to an ENI.

In some embodiments, the NBFs **604**, **608**, **610**, **616**, **622** and **624** may include the aspects of NBFs **102** and **104** in FIG. **1** above, and/or NBF **200** in FIG. **2** above. One skilled in the art will appreciate that many combinations exist that fall within the purview of this invention.

Hardware and Operating Environments

FIGS. **7**, **8**, **9** and **10** are diagrams of hardware and operating environments in which different embodiments can be

practiced. The description of FIGS. **7**, **8**, **9** and **10** provide an overview of computer hardware and suitable autonomic computing environments in conjunction with which some embodiments can be implemented. Embodiments are described in terms of a computer executing computer-executable instructions. However, some embodiments can be implemented entirely in computer hardware in which the computer-executable instructions are implemented in read-only memory. Some embodiments can also be implemented in client/server autonomic computing environments where remote devices that perform tasks are linked through a communications network. Program modules may be located in both local and remote memory storage devices in a distributed autonomic computing environment. Those skilled in the art will know that these are only a few of the possible computing environments in which the invention may be practiced and therefore these examples are given by way of illustration rather than limitation.

FIG. **7** is a block diagram of a computer cluster environment **700** in which different embodiments can be practiced. System **100**, apparatus **200**, **300**, **400**, **500**, **600**, method **2000** and ESNS **1100** and **1200** can be implemented on computer cluster environment **700**.

Computer cluster environment **700** may include a network **702**, such as an EtherFast 10/100 backbone, that is operably coupled to a cluster server **704** and a plurality of computers **706**, **708**, **710** and **712**. One possible embodiment of the computers is computer **802** described below with reference to FIG. **8**. The plurality of computers can include any number of computers, but some implementations may include 7, 16, 32 and as many as 512 computers. The ESNSs and NBFs described above can be distributed on the plurality of computers.

One example of the computer cluster environment **700** is a Beowolf computer cluster. The computer cluster environment **700** provides an environment in which a plurality of ESNSs and NBFs can be hosted in an environment that facilitates cooperation and communication between the ESNSs and the NBFs.

FIG. **8** is a block diagram of a hardware and operating environment **800** in which different embodiments can be practiced. Computer **802** may include a processor **804**, which may be a microprocessor, commercially available from Intel, Motorola, Cyrix and others. Computer **802** may also include random-access memory (RAM) **806**, read-only memory (ROM) **808**, and one or more mass storage devices **810**, and a system bus **812**, that operatively couples various system components to the processing unit **804**. The memory **806**, **808**, and mass storage devices, **810**, are illustrated as types of computer-accessible media. Mass storage devices **810** may be more specifically types of nonvolatile computer-accessible media and can include one or more hard disk drives, floppy disk drives, optical disk drives, and tape cartridge drives. The processor **804** can execute computer programs stored on the computer-accessible media.

Computer **802** may be communicatively connected to the Internet **814** via a communication device **816**. Internet **814** connectivity is well known within the art. In one embodiment, a communication device **816** may be a modem that responds to communication drivers to connect to the Internet via what is known in the art as a "dial-up connection." In another embodiment, a communication device **816** may be an Ethernet® or similar hardware network card connected to a local-area network (LAN) that itself is connected to the Internet via what is known in the art as a "direct connection" (e.g., T1 line, etc.).

A user may enter commands and information into the computer **802** through input devices such as a keyboard **818** or a pointing device **820**. The keyboard **818** may permit entry of textual information into computer **802**, as known within the art, and embodiments are not limited to any particular type of keyboard. Pointing device **820** may permit the control of the screen pointer provided by a graphical user interface (GUI) of operating systems such as versions of Microsoft Windows®. Embodiments are not limited to any particular pointing device **820**. Such pointing devices may include mice, touch pads, trackballs, remote controls and point sticks. Other input devices (not shown) could include a microphone, joystick, game pad, satellite dish, scanner, or the like.

In some embodiments, computer **802** may be operatively coupled to a display device **822**. Display device **822** may be connected to the system bus **812**. Display device **822** permits the display of information, including computer, video and other information, for viewing by a user of the computer. Embodiments are not limited to any particular display device **822**. Such display devices may include cathode ray tube (CRT) displays (monitors), as well as flat panel displays such as liquid crystal displays (LCDs). In addition to a monitor, computers may typically include other peripheral input/output devices such as printers (not shown). Speakers **824** and **826** provide audio output of signals. Speakers **824** and **826** may also be connected to the system bus **812**.

Computer **802** may also include an operating system (not shown) that could be stored on the computer-accessible media RAM **806**, ROM **808**, and mass storage device **810**, and may be and executed by the processor **804**. Examples of operating systems include Microsoft Windows®, Apple MacOS®, Linux®, UNIX®. Examples are not limited to any particular operating system, however, and the construction and use of such operating systems are well known within the art.

Embodiments of computer **802** are not limited to any type of computer **802**. In varying embodiments, computer **802** may comprise a PC-compatible computer, a MacOS®-compatible computer, a Linux®-compatible computer, or a UNIX®-compatible computer. The construction and operation of such computers are well known within the art.

Computer **802** may be operated using at least one operating system to provide a graphical user interface (GUI) including a user-controllable pointer. Computer **802** may have at least one web browser application program executing within at least one operating system, to permit users of computer **802** to access an intranet, extranet or Internet world-wide-web pages as addressed by Universal Resource Locator (URL) addresses. Examples of browser application programs include Netscape Navigator® and Microsoft Internet Explorer®.

The computer **802** may operate in a networked environment using logical connections to one or more remote computers, such as remote computer **828**. These logical connections may be achieved by a communication device coupled to, or a part of, the computer **802**. Embodiments are not limited to a particular type of communications device. The remote computer **828** could be another computer, a server, a router, a network PC, a client, a peer device or other common network node. The logical connections depicted in FIG. **8** include a local-area network (LAN) **830** and a wide-area network (WAN) **832**. Such networking environments are commonplace in offices, enterprise-wide computer networks, intranets, extranets and the Internet.

When used in a LAN-networking environment, the computer **802** and remote computer **828** may be connected to the local network **830** through network interfaces or adapters

834, which is one type of communications device **816**. Remote computer **828** may also include a network device **836**. When used in a conventional WAN-networking environment, the computer **802** and remote computer **828** may communicate with a WAN **832** through modems (not shown). The modem, which can be internal or external, is connected to the system bus **812**. In a networked environment, program modules depicted relative to the computer **802**, or portions thereof, can be stored in the remote computer **828**.

Computer **802** may also include power supply **838**. Each power supply can be a battery.

FIG. **9** is a block diagram of a multiprocessor hardware and operating environment **900** in which different embodiments can be practiced. Computer **902** may include a plurality of microprocessors, such as microprocessor **804**, **904**, **906**, and **908**. The four microprocessors of computer **902** may be one example of a multi-processor hardware and operating environment; other numbers of microprocessors may be used in other embodiments.

Similar to the computer cluster environment **700** in FIG. **7** above, the computer **902** may provide an environment in which a plurality of ESNSs and NBFs can be hosted in an environment that facilitates cooperation and communication between the ESNSs and the NBFs.

FIG. **10** is a block diagram of a hardware and operating environment **1000** which may include a quiesce component, according to an embodiment. The hardware and operating environment **1000** may solve the need in the art to reduce the possibility that an autonomic element will jeopardize the mission of the autonomic unit.

A quiesce component **1002** of an autonomic unit can render the autonomic unit inactive for a specific amount of time or until a challenging situation has passed. The quiesce component **1002** may be invoked when either an external supervisory entity or the autonomic unit itself determines that the autonomic unit could best serve the needs of the swarm by quiescing. Quiescing can render the autonomic unit temporarily inactive or disabled. Thus, the quiesce component **1002** may reduce the possibility that an autonomic element will jeopardize the mission of the autonomic element by deactivation or inactivating the autonomic element.

Quiesce time may be defined as the length of time taken to quiesce a system (to render it inactive), or the length of time between periods of activity (i.e. the length of time of inactivity). The quiescing may be somewhat analogous to the cell lifecycle, where cells may stop dividing and go into a quiescent state.

Components of the system **100**, apparatus **200**, **300**, **400**, **500**, **600**, **1000**, **1100**, **1200**, **1300**, **1400**, **1500**, **1600**, **1700**, **1800** and **1900** and methods **2000**, **2100**, **2200**, **2300**, **2400**, **2500**, **2600**, **2700**, **2800** and **2900** may be embodied as computer hardware circuitry or as a computer-readable program, or a combination of both.

More specifically, in one computer-readable program embodiment, the programs can be structured in an object-orientation using an object-oriented language such as Java, Smalltalk or C++, and the programs can be structured in a procedural-orientation using a procedural language such as COBOL or C. The software components may communicate in any of a number of ways that are well-known to those skilled in the art, such as application program interfaces (API) or interprocess communication techniques such as remote procedure call (RPC), common object request broker architecture (CORBA), Component Object Model (COM), Distributed Component Object Model (DCOM), Distributed System Object Model (DSOM) and Remote Method Invocation (RMI). The components execute on as few as one com-

puter as in computer **802** in FIG. **8**, or on at least as many computers as there are components.

Implementation of an Evolvable Synthetic Neural System in a Tetrahedral Architecture

Referring to FIG. **11**, a particular three-dimensional implementation is described in conjunction with the system overview in FIG. **1** and the apparatus described in FIG. **6**.

FIG. **11** is a diagram of a three dimensional (3D) hierarchical evolvable synthetic neural system (ESNS) **1100** according to an embodiment.

The 3D hierarchical ESNS **1100** may include a ruler subsystem **1102** and four worker subsystems **1104**, **1106**, **1108** and **1110**. Each subsystem in the 3D hierarchical ESNS **1100** may include one or more ESNSs such as system **100** or ESNS **600**.

The three dimensional architecture of 3D hierarchical ESNS **1100** may provide a three dimensional complexity. An implementation of ESNS **600** on a microprocessor such as microprocessor **804** described below with reference to FIG. **8**, may provide a synthetic neural system that reconciles the two dimensional nature of microprocessor technologies to the three dimensional nature of biological neural systems.

Implementation of Single Instrument Spacecraft to Prospect Asteroid Belts

Referring to FIG. **12**, a particular three-dimensional implementation for asteroid prospecting is described in conjunction with the system overview in FIG. **1** and the apparatus described in FIG. **6**.

FIG. **12** is a diagram of a heuristic neural system (HNS) **1200** according to an embodiment for a single instrument spacecraft to prospect asteroid belts.

Each spacecraft may be controlled by a subset of NBFs (SNBF) which in aggregate may provide the behavior of a subsystem of the mission. For example, a solar sailing SNBF **1202** may control sail deployment and subsequent configuration activity much as terrestrial sailors perform navigation and manage propulsion. A spacecraft inter communication subsystem SNBF **1204** may control communication with other workers and rulers. Also a housekeeping SNBF **1206** may control the spacecraft housekeeping. HNS **1200** may also include a ruler subsystem **1208** to coordinate all activities. Similarly, a spacecraft navigation and propulsion subsystem **1210** may control the navigation and propulsion, matching the navigation and propulsion to the current objectives.

In one embodiment, each spacecraft could be a worker in a totally autonomous space mission. The space mission may be configured as an autonomous nanotechnology swarm (ANTS). Each spacecraft in an ANTS may be assigned a specialized mission, much like ants in an ant colony have a specialized mission. Yet, the HNS architecture of each worker in an ANTS may provide coordination and interaction between each HNS that yields performance of the aggregate of the ANTS that exceeds the performance of a group of generalist workers.

More specifically, the SNBFs within HNS **1200** may have a hierarchical interaction among themselves much as the workers do in the entire ANTS collective. Hence, although many activities of the spacecraft could be controlled by individual SNBFs, a ruler SNBF may coordinate all of the SNBFs to assure that spacecraft objectives are met. Additionally, to have redundancy for the s/c mission, inactive workers and rulers may only participate if a member of their type is lost. In

addition, a hierarchical worker node can collapse to a non-hierarchical one, if all of the available sub-rulers for that node are lost.

In one particular application of an ANTS, a prospecting asteroid mission (PAM) may survey a large population or surface area targets, such as mainbelt asteroids. The primary objective of a PAM could be exploration of the asteroid belt in search of resources and material with astrobiologically relevant origins and signatures. The PAM may include a swarm of approximately 1000 spacecraft that includes approximately 10 types of specialist workers (e.g. HNS **1200**) with a common spacecraft bus that is organized into 10 subswarms of approximately 100 spacecraft each, having approximately 10 specialist HNSs.

In some embodiments, each individual spacecraft in a PAM may weigh 1 kilogram or less with a one meter diameter bodies and 100 meter² sails when fully deployed. Each spacecraft may be packaged into a 10 cm² sided cube. A swarm of 1000 of these spacecraft may fit into 1 meter³ weighing 1000 kilograms in deployment. Each spacecraft may also include a solar sail propulsion system that requires no expendable supplies and a small nuclear battery that provides sufficient power to each worker. Thus, the prospecting asteroid mission may be self-directed and can possibly be self-sustaining for tens of years.

FIG. **13** is a block diagram of an autonomic entity management system **1300** according to an embodiment. The system **1304** is a generic system because it represents a myriad of devices, processes, or device and process that perform a task in accordance to its programming or design. The system **1304** could be software for updating or for synchronizing a file, could be a worker craft containing unique instrument for data gathering in an autonomous nano-technology swarm, or the system **1304** could be an application for managing resources in networks or general purpose computers. The system **1304** can have multiple applications and capabilities such as self healing and self monitoring, but as a minimum, the system **1304** is required to have a way for communicating a functional status and operating state signal to the managing autonomous entity manager **1302**. The system **1304** may exhibit the properties of being self managing and self governing, often termed autonomic, pervasive, sustainable, ubiquitous, biologically inspired, organic or with similar such terms.

While the autonomic entity management system **1300** is shown as discrete autonomic components it should be understood that autonomic computing is dependent on many disciplines for its success; not least of these is research in agent technologies. The autonomic manager **1302** or system **1304** can be agents themselves containing functionality for measurement and event correlation and support for policy based control.

The functional status may be represented by a heart beat monitor (HBM) signal that indicates that the system **1304** is still functioning as designed. The HBM signal is fundamentally an "I am alive" signal to the autonomic manager, such as autonomic entity **1302**, indicating that the system is functioning. These signals can be communicated from system **1304** through an appropriate bidirectional communication link **1306**. The response from the autonomous manager **1302** can use the same link to influence system **1304**. The communication link can be one or more radio link, data bus, a call procedure when implemented as software, or any other link presently existing or to be developed for facilitating communication between autonomic elements.

The operating state signal may be represented by a pulse monitor (PBM) signal. The PBM signal can be used by the

autonomic entity **1302** or autonomic manager to infer potential warning conditions so preparations can be made to handle changing processing loads, impact on mission objectives, planning for correction, and possible substitute or reassignment of role or functionality to perform the desired objectives of system **1304**. Autonomous manager **1302** has the additional option of generating a stay alive signal that can be used to safeguard resources, safeguard the completion of the objectives, and safeguard the system **1304** by removing the offending agent or the sub-component of system **1304**. The stay alive signal borrows from the process of apoptosis in biological systems for cell self-destruction to maintain growth and protect the biological system from catastrophe. In biological systems, self-destruct is an intrinsic property that is delayed due to the continuous receipt of biochemical reprieves. The process is referred to as apoptosis, meaning drop out due to the origin of the word derived dropping of leaves from trees; i.e., loss of cells that ought to die in the midst of the living structure. This process has also been nicknamed death by default, where cells are prevented from putting an end to themselves due to constant receipt of biochemical stay alive signals. In the present arrangement, self-destruction is usable in preventing race conditions and undesirable emergent behavior that have been shown to influence system performance and thus mission objectives. While self-destruction can be viewed as a last resort situation to prevent further damage; in other situations, such as security of the agent or system **1304**, self-destruction can be used as an intrinsic part of the process such as blocking the autonomic entity from communicating or using the resources of the system.

FIG. **14** is a diagram representation of a plurality of autonomic entities that have been assembled to perform a task. These entities may be Self-configuring: adapt automatically to the dynamically changing environments; Self-optimizing: monitor and tune resources automatically; Self-protecting: anticipate, detect, identify, and protect against attacks from anywhere; and, Self-healing: discover, diagnose, and react to disruptions. As shown with reference to autonomic entities **1418** and **1420** autonomic computing may have a self-aware layer and an environment aware layer. The self-aware layer of the autonomic entity (agent or other) may be comprised of a managed component and autonomic manager, which can be an agent, termed a self-managing cell (SMC). Control loops with sensors (self-monitor) and effectors (self-adjuster) together with system knowledge and planning/adapting policies may allow the autonomic entities to be self aware and to self manage. A similar scheme may facilitate environment awareness—allowing self managing if necessary, but without the immediate control to change the environment; this could be affected through communication with other autonomic managers that have the relevant influence, through reflex or event messages. The autonomic entities may be arranged or assigned distinctive roles such as worker entities, coordinating or managing entities, and message entities. Based on the task a ruler entity could be assigned a set of worker entities to manage inclusive of determining if a stay alive signal ought to be withdrawn. Further, the communication between the ruler and the worker may be facilitated through the message entity. The message entity could have the additional task of communicating with a remote system. In the case of space exploration, the remote system could be mission control on earth, mission control on an orbital platform, or any other arrangement that can facilitate that is external to the collection of autonomic elements. It is foreseeable that the remote system could be an autonomic entity acting like the project manager for the mission. Communication with mission control will be

limited to the download of science data and status information. An example of such a grouping is shown in FIG. **14** where autonomic entity **1402** is shown as a ruler entity, autonomic entity **1410** as a message entity, and autonomic entities **1418** and **1420** are examples of worker entities. In terms of hardware, these entities can be all identical with the discernable difference being programming to accomplish assigned tasks. An added advantage to having identical hardware is replacing failed entities, which can be accomplished by activating software code found in the autonomic entity. If hardware differences exist they can be based on specialized equipment suitable for a particular task. However, at a minimum, certain functions or roles, such as ruler and messenger, may be expected to be within the skill set of all the autonomic entities.

As shown in FIG. **14**, ruler autonomic entity **1402** may comprise a program or process **1404** executing in ruler entity **1402**. Ruler entity **1402** can be implemented using a data processing system, such as data processing system **902** in FIG. **9**, or in the form of an autonomous agent compiled by a data processing system. In the alternative, the ruler entity could be an autonomous nano-technology swarm that is launched from a factory ship for exploring planets, asteroids, or comets. Further, analysis module **1406** or agent as executed by ruler entity **1402** can be used to monitor process **1404** and to receive pulse monitor and heart beat monitor signals from worker entities through the messenger entity. When analysis module **1406** is used to monitor process **1404** it may be used to detect errors or problems with the operation of process **1404**.

As shown in FIG. **14**, analysis agent **1406** can include an evaluator or other monitoring engine used to monitor the operation of process **1404**. Analysis agent **1406** may be executed in response to some event. This event can be a periodic event, such as the passage of some period of time, data received from one or more of the worker entities. Further, the event can be the initialization of internal procedures in process **1404** or the starting or restarting of ruler entity **1402**. Depending on the particular implementation, analysis agent **1406** can continuously run in the background monitoring process **1404** and analyzing the worker entity signals. See method **2100** in FIG. **21** below for actions taken by analysis agent module **1406** in formulating a strategy for the worker entities. Further, analysis agent **1406** may be subject to any self-healing routines found in ruler entity **1402**.

This monitoring by analysis agent **1406** may be based on rules stored in behavior storage **1408**, which could be used to compare the actual behavior of the received data to an expected behavior as defined in behavior storage **1408**. In the present arrangement, behavior storage **1408** (ruler entity **1402**) may be a collection of rules that can be updated by a remote computer through the messenger entity that reflects most current fixes (self-healing) or repair procedures and responses to worker entities upon the occurrence of an event, change in condition, or deviation from a normal operation. Behavior storage **1408** can be narrowly tailored based on the use and purpose of the autonomic entity, such as messenger entity **1410** and have only those procedures needed to perform its programming.

When messenger entity connects to remote computer at a command and control station, database **1416** can be updated with information that can later be used to program ruler entity or worker entity. In most cases a copy of the rules in database **1416** contains the most up-to-date information. If the objective changes or a solution to a problem requires an updated version not found within the autonomic entity, the entities may attempt to contact message entity **1410** to see if more

recent or up-to-date information is available. If updates are available, these updates may be sent to the requesting entity for processing.

The information in behavior storage **1408** and databases in messenger and worker entity can include an array of values that are expected when selected process or operations are implemented in the respective entity. Examples processes may be initializing software, timing requirements, synchronization of software modules, and other metrics that can provide information concerning the running of a process within the respective entity. Examples operations may be data gathering, processing of information, controlling machinery, or any other operation where data processing systems are employed. These expected values can be compared to determine if an error condition has occurred in the operation of the entity. An error condition can be analyzed to determine its causes and possible correction. In the case of a worker entity, the error can be internally analyzed to select the appropriate self-healing procedure and the error can be sent to the ruler entity to be analyzed by analysis agent **1406** using the rules in behavior storage **1408**. Based on the analysis, the ruler entity can elect to either withdraw the stay alive signal to the malfunctioning worker entity or wait a selected period to generate one or more stay alive signal, withdrawal of a stay alive signal, or a self-destruct signal. If the stay alive signal is withdrawn, the malfunctioning entity could be disconnected from the operation and the assigned to another entity or partially performed by the remaining entity to insure its completion.

FIG. **15** is a block diagram of an autonomous entity management system **1500** according to an embodiment. The system **1500** may be a generic system because it represents a myriad of devices, processes, or device and process that perform a task in accordance to its programming or design. The illustrated system **1500** represents an instance when an autonomous system **1504** encounters an anonymous autonomous agent **1502**. An anonymous autonomous agent can be a visiting agent, a mobile agent that can enter the sphere of influence of the autonomous system **1504**, or any device for which the autonomous system **1504** has no established relationship. Example encounters may be a wireless device (agent) and communication tower (system), a client and server, a video subscriber and video provider, a process and an operating system. System **1500** may solve the need in the art for management of autonomous entities that can be functionally extracted from an environment upon the occurrence of a predetermined condition such as a potential security breach.

The autonomous system **1504** may comprise one or more autonomous agents **1508**, **1510**, and **1512** all performing assigned functions and roles. As noted earlier, roles can be a combination of ruler, messenger, and worker. Functions may be data gathering, communication functions, scheduling, controlling, security, and so forth. Upon detecting anonymous autonomous agent **1502** the assigned autonomous agent for performing security functions for autonomous system **1504** may interrogate the anonymous autonomous agent **1502**, requesting production of valid credentials. It should be noted at this point that detection can occur by employing various schemes such as when the anonymous autonomous agent **1502** requests resources from the system **1504** or from any autonomous entity that forms part of the system, response to polling signals from the autonomous system **1504**, or through a friend or foe signal that indicates the presence of an anonymous entity **1502** in proximity to the autonomous system **1504**.

To the autonomous system **1504**, security may be important because of compromises by the accidental misuse of hosts by agents, as well as the accidental or intentional misuse

of agents by hosts and agents by other agents. The result may be damage, denial-of-service, breach-of-privacy, harassment, social engineering, event-triggered attacks, or compound attacks. To prevent security breaches it may be important to ensure that visiting agents have valid and justified reasons for being there as well as providing security to the visiting agent with interaction with other agents and host. Upon detection the visiting agent **1502** may be sent an asynchronous ALice signal (Autonomic license) **1506** requiring valid credentials from the agent **1502**. The anonymous agent **1502** may need to work within the autonomic system **1504** to facilitate self-management, as such the anonymous agent **1502** and its host may need to be able to identify each other's credentials through such as an ALice signal. The autonomic system **1504** can establish certain response characteristics for the returned signal from the agent **1502**. For example, the autonomic system **1504** can require a response in an appropriate format, within a certain timeout period, and with a valid and justified reason for being within the locust of interest or domain of the autonomous system **1504**. For protection the autonomic system **1504** may make an assessment of the quality of the response from the anonymous agent **1502** to ascertain the potential of the agent for causing harm to the autonomous system **1504**. Based on this determination the autonomous system **1504** can control the type of interaction with the agent **1502**. The agent can be destroyed, blocked, partially blocked, stay alive signal withdrawn, or allowed to communicate with other agents within the autonomous system **1504**. The protection can be triggered at any level of infraction or by a combination of infractions by the anonymous autonomous agent **1502** when responding to the ALice signal. If the agent **1502** fails to identify itself appropriately following an ALice interrogation, the agent **1502** may be blocked from the system and given either a self-destruct signal, or its "stay alive" reprieve is withdrawn. The consequence of unacceptable response to an anonymous agent **1502**, should it fail to do so within a timeout period, the agent **1502** may be determined to be an intruder or other invalid agent (process) and consequently it is destroyed and/or excluded from communicating with other agents **1508**, **1510**, **1512** in the system. As an alternative to the ALice signal, a quiesce signal, command or instruction can be sent. The quiesce signal is discussed in more detail in conjunction with FIGS. **10**, **23** and **24**.

FIG. **16** is a hierarchical chart of an autonomous entity management system **1600** according to an embodiment. Properties that a system may possess in order to constitute an autonomic system are depicted in the autonomous entity management system **1600**.

General properties of an autonomic (self-managing) system may include four objectives defined by International Business Machines **1602**: self-configuring **1604**, self-healing **1606**, self-optimizing **1608** and self-protecting **1610**, and four attributes **1612**: self-awareness **1614**, environment-awareness **1616**, self-monitoring **1618** and self-adjusting **1620**. One skilled in the art will recognize that other properties also exist, such as self-quiescing **1625**. Essentially, the objectives **1602** could represent broad system requirements, while the attributes **1612** identify basic implementation mechanisms.

Self-configuring **1604** may represent an ability of the system **1600** to re-adjust itself automatically; this can simply be in support of changing circumstances, or to assist in self-healing **1606**, self-optimization **1608** or self-protection **1610**. Self-healing **1606**, in reactive mode, is a mechanism concerned with ensuring effective recovery when a fault occurs, identifying the fault, and then, where possible, repairing it. In proactive mode, the self-healing **1606** objective may monitor

vital signs in an attempt to predict and avoid “health” problems (i.e. reaching undesirable situations).

Self-optimization **1608** may mean that the system **1600** is aware of ideal performance of the system **1600**, can measure current performance of the system **1600** against that ideal, and has defined policies for attempting improvements. The system **1600** can also react to policy changes within the system as indicated by the users. A self-protecting **1610** system **1600** can defend the system **1600** from accidental or malicious external attack, which necessitates awareness of potential threats and a way of handling those threats.

Self-managing objectives **1602** may require awareness of an internal state of the system **1600** (i.e. self-aware **1614**) and current external operating conditions (i.e. environment-aware **1616**). Changing circumstances can be detected through self-monitoring and adaptations are made accordingly (i.e. self-adjusting **1620**). Thus, system **1600** may have knowledge of available resources, components, performance characteristics and current status of the system, and the status of interconnections with other systems, along with rules and policies of therein can be adjusted. Such ability to operate in a heterogeneous environment may require the use of open standards to enable global understanding and communication with other systems.

These mechanisms may not be independent entities. For instance, if an attack is successful, this may include self-healing actions, and a mix of self-configuration and self-optimisation, in the first instance to ensure dependability and continued operation of the system, and later to increase the self-protection against similar future attacks. Finally, these self-mechanisms could ensure there is minimal disruption to users, avoiding significant delays in processing.

Other self*properties have emerged or have been revisited in the context of autonomicity. We highlight some of these briefly here. Self-***1622** may be self-managing properties, as follows. Self-anticipating is an ability to predict likely outcomes or simulate self-*actions. Self-assembling is an assembly of models, algorithms, agents, robots, etc.; self-assembly is often influenced by nature, such as nest construction in social insects. Self-assembly is also referred to as self-reconfigurable systems. Self-awareness is “know thyself” awareness of internal state; knowledge of past states and operating abilities. Self-chop is the initial four self-properties (Self-Configuration **1604**, Self-Healing **1606**, Self-Optimisation **1608** and Self-Protection **1610**). Self-configuring is an ability to configure and re-configure in order to meet policies/goals. Self-critical is an ability to consider if policies are being met or goals are being achieved (alternatively, self-reflect). Self-defining is a reference to autonomic event messages between Autonomic Managers: contains data and definition of that data-metadata (for instance using XML). In reference to goals/policies: defining these (from self-reflection, etc.). Self-governing is autonomous: responsibility for achieving goals/tasks. Self-healing is reactive (self-repair of faults) and Proactive (predicting and preventing faults). Self-installing is a specialized form of self-configuration-installing patches, new components, etc or re-installation of an operating system after a major crash. Self-managing is autonomous, along with responsibility for wider self-*management issues. Self-optimizing is optimization of tasks and nodes. Self-organized is organization of effort/nodes; particularly used in networks/communications. Self-protecting is an ability of a system to protect itself. Self-reflecting is an ability to consider if routine and reflex operations of self-*operations are as expected and can involve self-simulation to test scenarios. Self-similar is self-managing components created from similar components that adapt to a specific task, for

instance a self-managing agent. Self-simulation is an ability to generate and test scenarios, without affecting the live system. Self-aware is self-managing software, firmware and hardware.

FIG. **17** is a block diagram of an autonomic element **1700** according to an embodiment. Autonomic element **1700** may include an element **1702** that is operably coupled to sensors and **1704** and effectors **1706**.

Autonomic element **1700** may also include components that monitor **1708**, execute **1710**, analyze **1712** and plan **1714**; those components may access knowledge **1716**. Those components can interact with sensors **1718** and effectors **1720**.

FIG. **18** is a block diagram of autonomy and autonomicity **1800** at a high system level, according to an embodiment. A high level perspective for an intelligent machine design is depicted in FIG. **18**. This diagram of autonomy and autonomicity **1800** includes intelligent machine design and system level autonomy and autonomicity.

FIG. **18** describes three levels for the design of intelligent systems:

1) Reaction **1802**—the lowest level, where no learning occurs but there is immediate response to state information coming from sensory systems **1804**.

2) Routine **1806**—middle level, where largely routine evaluation and planning behaviors take place. Input is received from sensory system **1804** as well as from the reaction level and reflection level. This level of assessment results in three dimensions of affect and emotion values: positive affect, negative affect, and (energetic) arousal.

3) Reflection **1808**—top level, receives no sensory **1804** input or has no motor **1810** output; input is received from below. Reflection is a meta-process, whereby the mind deliberates about itself. Essentially, operations at this level look at the system’s representations of its experiences, its current behavior, its current environment, etc.

As illustrated, input from, and output to, the environment only takes place within the reaction **1802** and routine **1806** layers. One can consider that reaction **1802** level essentially sits within the “hard” engineering domain, monitoring the current state of both the machine and its environment, with rapid reaction to changing circumstances; and, that the reflection **1802** level can reside within an artificial domain utilizing its techniques to consider the behavior of the system and learn new strategies. The routine **1806** level can be a cooperative mixture of both. The high-level intelligent machine design may be appropriate for autonomic systems as depicted here in FIG. **18**, in consideration of the dynamics of responses including reaction **1802** and also for reflection **1808** of self-managing behavior.

As depicted autonomic computing can reside within the domain of the reaction **1802** layer as a result of a metaphoric link with the autonomic biological nervous system, where no conscious or cognitive activity takes place. Other biologically-inspired computing (also referred to as nature-inspired computing, organic computing, etc.) may provide such higher level cognitive approaches for instance as in swarm intelligence. Within the autonomic computing research community, autonomicity may not normally be considered to imply this narrower view. Essentially, the autonomic self-managing metaphor can be considered to aim for a user/manager to be able to set high-level policies, while the system achieves the goals. Similar overarching views exist in other related initiatives and, increasingly, they are influencing each other.

In terms of autonomy and autonomicity, autonomy can be considered as being self-governing while autonomicity can be considered being self-managing. At the element level, an

element may have some autonomy and autonomic properties, since to self-manage implies some autonomy, while to provide a dependable autonomous element requires such autonomic properties as self-healing along with the element's self-directed task. From this perspective, it would appear that the separation of autonomy and autonomicity as characteristics will decrease in the future and eventually will become negligible. On the other hand, at the system level if one considers again the three tiers of the intelligent machine design (reaction **1802**, routine **1806**, and reflection **1808**) and accepts the narrower view of autonomicity, there is a potential correlation between the levels. That is, the reaction **1802** level correlates with autonomicity, and the reflection **1808** level correlates with autonomy; autonomy as in self-governing of the self-managing policies within the system.

FIG. **19** is a block diagram of an architecture of an autonomic element (AE) **1900** according to an embodiment that includes reflection and reflex layers. The autonomic element **1900** may include a managed component (MC) **1902** that is managed, and the autonomic element **1900** may further include an autonomic manager (AM), not shown. The AM may be responsible for the MC **1902** within the AE **1900**. The AM can be designed as part of the component or provided externally to the component, as an agent, for instance. Interaction of the autonomic element **1900** can occur with remote (external) autonomic managers (cf. the autonomic communications channel **1906**) through virtual, peer-to-peer, client-server or grid configurations.

An important aspect of the architecture of many autonomic systems can be sensors and effectors, such as shown in FIG. **17**. A control loop **1908** can be created by monitoring **1910** behavior through sensors, comparing this with expectations (knowledge **1716**, as in historical and current data, rules and beliefs), planning **1912** what action is necessary (if any), and then executing that action through effectors. The closed loop of feedback control **1908** can provide a basic backbone structure for each system component. FIG. **19** describes at least two control loops in the autonomic element **1900**, one for self-awareness **1914** and another **1908** for environmental awareness.

In some embodiments, the self-monitor/self-adjuster control loop **1914** can be substantially similar to the monitor, analyze, plan and execute (MAPE) control loop described in FIG. **17**. The monitor-and-analyze parts of the structure can perform a function of processing information from the sensors to provide both self-awareness **1914** and an awareness **1908** of the external environment. The plan-and-execute parts can decide on the necessary self-management behavior that will be executed through the effectors. The MAPE components can use the correlations, rules, beliefs, expectations, histories, and other information known to the autonomic element, or available to it through the knowledge repository **1716** within the AM **1904**.

A reflection component **1916** may perform analysis computation on the AE **1900** (cf. the reflection component **1916** within the autonomic manager). In terms of an autonomic system, reflection can be particularly helpful in order to allow the system to consider the self-managing policies, and to ensure that the policies are being performed as expected. This may be important since autonomicity involves self-adaptation to the changing circumstances in the environment. An autonomic manager communications (AM/AM) component **1918** can also produce a reflex signal **1920**. A self adjuster **1922** can be operably coupled to a self-monitor **1924** in the self control loop **1914**.

Method Embodiments

In the previous section, apparatus embodiments are described. In this section, the particular methods of such

embodiments are described by reference to a series of flowcharts. Describing the methods by reference to a flowchart enables one skilled in the art to develop such programs, firmware, or hardware, including such instructions to carry out the methods on suitable computers, executing the instructions from computer-readable media. Similarly, the methods performed by the server computer programs, firmware, or hardware can also be composed of computer-executable instructions. In some embodiments, method **2000** may be performed by a program executing on, or performed by firmware or hardware that is a part of a computer, such as computer **802** in FIG. **8**.

FIG. **20** is a flowchart of a method **2000** to construct an environment to satisfy increasingly demanding external requirements according to an embodiment.

Method **2000** may include instantiating **2002** an embryonic evolvable neural interface (ENI), such as inter-ENI **106**. In one embodiment, the embryonic ENI lacks a complete specification of the operational characteristics of the ESNS or an ENI. The embryonic ENI can be a neural thread possessing only the most primitive and minimal connectivity.

Method **2000** can further include evolving **2004** the embryonic ENI towards complex complete connectivity. Specifications of the inter-ENI **106** can be developed from the initial embryonic form. Thus a very complex problem that in some embodiments may be represented by a complete specification, can be replaced by a more simple specification of the embryonic ENI that is evolved to meet increasingly demanding requirements. Progression from an embryonic state to a more complex state can avoid the necessity of specifying the complex complete connectivity initially, but rather can reduce the problem to one of developing methods to drive the evolution of simple limited connectivity to complex complete connectivity.

An adaptive or evolutionary nature of an artificial intelligence construct in method **2000** can be predicated on an active revision of the embryonic ENI to meet external action requirements for a sensory input. In particular, the ENI, which handles both the intra-NBF and inter-NBF connectivity, can evolve due to changing conditions that are either driven by training requirements or operational requirements.

In some embodiments, method **2000** may be implemented as a computer data signal embodied in a carrier wave that represents a sequence of instructions, which, when executed by a processor, such as processor **804** in FIG. **8**, causes the processor to perform the respective method. In other embodiments, method **2000** may be implemented as a computer-accessible medium having executable instructions capable of directing a processor, such as processor **804** in FIG. **8**, to perform the respective method. In varying embodiments, the medium can be a magnetic medium, an electronic medium, or an optical medium.

FIG. **21** is a flowchart of a method **2100** to construct an environment to satisfy increasingly demanding external requirements according to an embodiment where a ruler entity decides to withdraw or generate a stay alive signal. Method **2100** may solve the need in the art for management of autonomous entities that can be functionally extracted from an environment upon the occurrence of a predetermined condition. Method **2100** can begin with action **2102** when receiving a signal from a managed entity.

Action **2102** can receive a heart beat monitor (HBM) signal and pulse monitor (PBM) signal from a managed entity such as worker entities **1418** or **1420**. The HBM signal can be an indication that the managed entity (worker entity) is operating. The HBM can be an "ON/OFF" state signal, an indication that a process is being performed, or any other signal that can

convey information that the worker entity is alive or active. The PBM signal may extend the HBM signal to incorporate reflex/urgency/health indicators from the autonomic manager representing its view of the current self-management state. The PBM signal can thus convey the performance and characteristics of the entity in the form of engineering data summarization to add context to the received HBM signal. Engineering data summarization can be a set of abstractions regarding sensor that may comprise rise and fall of data by a certain amount, external causes for parameter deviations, actual numerical value of the parameters being summarized, warning conditions, alarm conditions, and any other summarization that would convey the general health of the system. Once the HBM and PBM signals have been received, control can be forwarded to action **2104** for further processing.

In action **2104**, an analysis of the HBM and PBM signal may be performed to determine trends and possible areas of concern. Some purposes of the analysis may be to determine exceedance from a predetermined condition, make projection through simulation and data modeling areas of parameters that can lead to the failure of the worker entity or that might jeopardize the assigned mission, and ascertain the quality of performance of the system. The analysis can be performed by using regression techniques, neural network techniques, statistical techniques, or any other technique that can convey information about the state of a system or emergent behavior of the system. Once the analysis has been performed, control can pass to action **2106** for further processing.

In action **2106**, an alarmed condition may be determined. In action **2106**, the analysis of action **2104** may be consulted to determine if there is one or more alarm condition that can trigger the withdrawal of a stay alive signal. If it is determined that there are no alarm conditions, control may be passed to action **2108** so as to generate a stay alive signal. In the event that an alarm condition is present, control may be passed to action **2110** for further processing.

In action **2110**, a determination may be made to ascertain whether the identified alarmed condition of action **2106** is recoverable by the managed entity, such as worker entities **1418** and **1420** of FIG. **14**. When an alarmed condition is determined to be recoverable, control may be passed to action **2108** to generate a stay alive signal. When an alarmed condition is determined not to be recoverable, control may be passed to action **2112** to withdraw the stay alive signal.

FIG. **22** is a flowchart of a method **2200** for ascertaining the recoverability of an alarmed condition determined at action **2106** according to an embodiment. Method **2200** may solve the need in the art for management of autonomous entities that can be functionally extracted from an environment upon the occurrence of a predetermined condition. Method **2200** is one possible embodiment of the action in FIG. **21** above of determining **2110** if the identified alarmed condition is recoverable.

Method **2200** may begin with action **2202** when receiving one or more alarmed condition. In action **2202**, there may be a determination if an incorrect operation from the managed system has been identified in action **2104** of FIG. **21**. An incorrect operation can range from not initializing sensors to failing to self-heal when internal decision logic recommends as an appropriate cause of action. In action **2202** in addition to determining if an incorrect operation has been identified, it may also be possible to ascertain the number of devices or processes within the entity that registered an incorrect operation. If at least one incorrect operation is determined, the action may transfer the identity of the unit to evaluation block **2208** for further processing.

In action **2204**, there may be a determination whether emergent behavior from the managed system has been identified in action **2104** of FIG. **21**. An emergent behavior or emergent property can appear when a number of entities (agents) operate in an environment forming behaviors that are more complex as a collective. The property itself can often be unpredictable and unprecedented and can represent a new level of the system's evolution. This complex behavior in the context of control system may be known as non-linearity, chaos, or capacity limits. The complex behavior or properties may not be properties of any single such entity, nor can they easily be predicted or deduced from behavior in the lower-level entities. One reason why emergent behavior occurs may be that the number of interactions between autonomic components of a system increases combinatorially with the number of autonomic components, thus potentially allowing for many new and subtle types of behavior to emerge. Nothing may directly command the system to form a pattern, but the interactions of each part (entities) to its immediate surroundings may cause a complex process that leads to order. Emergent behavior can be identified based on parameters that give rise to the complex behavior in a system such as demands on resources. Once an emergent behavior condition has been identified, the information may be forwarded to evaluation block **2208** for further processing.

In action **2206**, a determination may be made of alarm conditions that can have an impact on the success of the mission or task by which all entities are striving to accomplish. The impact could be the ability to accomplish individual tasks or the potential for failure of the overall mission by permitting an entity to stay alive. This impact can be determined through Bayesian belief networks, statistical inference engines, or by any other presently developed or future developed inference engine that can ascertain the impact on a particular task if one or more agent is showing incorrect operation or harmful emergent behavior. Once the impact has been determined the information may be passed to evaluation block **2208** for further processing.

Evaluation block **2208** may marshal the incorrect operation identified in action **2202**, the emergent behavior in action **2204**, or the effect on mission in action **2206** to suggest a course of action that the managed entities should adopt, which in the present arrangement is based on a stay alive signal. The determination of withdrawing or affirming the stay alive signal can be based on the occurrence of one or more of the identified alarmed conditions, or a combination of two or more of the identified alarmed conditions. For example, the stay alive signal could be withdrawn if there is emergent behavior and there would be an effect on the mission. In the alternative, the stay alive signal could be affirmed if there was only emergent behavior, or incorrect operation. Once the evaluation is determined, control may be passed to decision block **2210** for further processing in accordance to the decision made in evaluation block **2208**.

In action **2210**, if the desired control instruction is to maintain the stay alive signal, control can be passed to action **2108** for further processing. In the alternative, a withdrawal of the stay alive signal can be sent to action **2112** for further processing. It should be noted that generating a stay alive signal may be equivalent to generating a stay alive signal, affirming a stay alive signal, not withdrawing a stay alive signal, or any other condition that can determine if an entity is to perish or to extinguish unless allowed to continue by another entity. The other entity might be a managing entity since it can determine the outcome (life or death) of an entity.

FIG. **23** is a flowchart of a method **2300** to construct an environment to satisfy increasingly demanding external

requirements according to an embodiment where a ruler entity decides to withdraw or generate a stay-awake signal. Method **2300** may solve the need in the art to reduce the possibility that an autonomic element will jeopardize the mission of the autonomic element.

Method **2300** may begin with action **2102** when receiving a signal from a managed entity. Action **2102** can receive a heart beat monitor (HBM) signal and pulse monitor (PBM) signal from a managed entity such as worker entities **1418** or **1420**. In some embodiments, the HBM signal is an indication that the managed entity (worker entity) is operating. The HBM can be an "ON/OFF" state signal, an indication that a process is being performed, or any other signal that can convey information that the worker entity is awake or active. The PBM signal may extend the HBM signal to incorporate reflex/urgency/health indicators from the autonomic manager representing its view of the current self-management state. The PBM signal may thus convey the performance and characteristics of the entity in the form of engineering data summarization to add context to the received HBM signal. Engineering data summarization could be a set of abstractions regarding sensors that, in some embodiments, could comprise rise and fall of data by a certain amount, external causes for parameter deviations, actual numerical value of the parameters being summarized, warning conditions, alarm conditions, and any other summarization that would convey the general health of the system. Once the HBM and PBM signals have been received, control can be forwarded to action **2104** for further processing.

In action **2104**, an analysis of the HBM and PBM signal may be performed to determine trends and possible areas of concern. The purpose of the analysis could be to determine that a predetermined condition has been exceeded, generate a projection through simulation and data modeling areas of parameters that can lead to the failure of the worker entity or that might jeopardize the assigned mission, and ascertain the quality of performance of the system. The analysis can be performed by using regression techniques, neural network techniques, statistical techniques, or any other technique that can convey information about the state of a system or emergent behavior of the system. Once the analysis has been performed, control can be passed to action **2106** for further processing.

In action **2106**, an alarmed condition can be determined. In action **2106**, the analysis of action **2104** may be consulted to determine if there is one or more alarm condition that can trigger the withdrawal of a stay-awake signal. If it is determined that there are no alarm conditions, control may be passed to action **2302** so as to generate a stay-alive signal. In the event that an alarm condition is present, control may be passed to action **2304** for further processing.

In action **2304**, a determination can be made to ascertain if the identified alarmed condition of action **2106** is recoverable by the managed entity such as worker entities **1418** and **1420** of FIG. **14**. When an alarmed condition is determined not to be recoverable, control may be passed to action **2112** to withdraw the stay-alive signal. Method **2400** below could be one embodiment of determining **2304** if the identified alarmed condition is recoverable. When an alarmed condition is determined to be recoverable, control may be passed to action **2308** in which a determination can be made to ascertain if quiescing the managed entity and/or subsequent recovery is possible. When quiescence of the managed entity and/or need for later recovery is determined as not possible, control can pass to action **2302** to generate a stay-awake/stay-alive-signal. When quiescence of the managed entity is determined as possible and/or needed in action **2308**, control can pass to

action **2310**, to withdraw the stay-awake signal. Thus, quiescing the managed entity may solve the need in the art to functionally extract the managed entity from an environment upon the occurrence of an alarmed condition. Quiescence may be a less encompassing alternative to withdrawing the stay-awake signal of apoptosis. Method **2300** can allow an agent or craft that is in danger or endangering the mission to be put into a self-sleep mode, then later reactivated or self-destructed.

FIG. **24** is a flowchart of a method **2400** for ascertaining the recoverability of an alarmed condition determined at action **2304**. Method **2400** may solve the need in the art for management of autonomous entities that can be functionally extracted from an environment upon the occurrence of a predetermined condition. Method **2400** may begin with action **2202** when receiving one or more alarmed condition.

In action **2202**, there may be a determination if an incorrect operation from the managed system has been identified in action **2104** of FIG. **21**. An incorrect operation can range from not initializing sensors to failing to self-heal when internal decision logic recommends as an appropriate cause of action. In action **2202**, in addition to determining if an incorrect operation has been identified, it may also be possible to ascertain the number of devices or processes within the entity that registered an incorrect operation. If at least one incorrect operation is determined, the action can transfer the identity of the unit to evaluation block **2208** for further processing.

In action **2204**, there may be a determination of emergent behavior from the managed system that has been identified in action **2104** of FIG. **21**. An emergent behavior or emergent property can appear when a number of entities (agents) operate in an environment forming behaviors that are more complex as a collective. The property itself may often be unpredictable and unprecedented and can represent a new level of the system's evolution. This complex behavior in the context of control system can be known as non-linearity, chaos, or capacity limits. The complex behavior or properties may not be properties of any single such entity, nor can they easily be predicted or deduced from behavior in the lower-level entities. One reason why emergent behavior occurs could be that the number of interactions between autonomic components of a system increases combinatorially with the number of autonomic components, thus potentially allowing for many new and subtle types of behavior to emerge. Nothing may directly command the system to form a pattern, but instead the interactions of each part (entities) to its immediate surroundings can cause a complex process that leads to order. Emergent behavior can be identified based on parameters that give rise to the complex behavior in a system such as demands on resources. Once an emergent behavior condition has been identified, the information may be forwarded to evaluation block **2208** for further processing.

In action **2206**, a determination can be made of alarm conditions that can have an impact on the success of the mission or task which all entities are striving to accomplish. The impact could be the ability to accomplish individual tasks or the potential for failure of the overall mission by permitting an entity to stay awake. This impact can be determined through Bayesian belief networks, statistical inference engines, or by any other presently developed or future developed inference engine that can ascertain the impact on a particular task if one or more agent is showing incorrect operation or harmful emergent behavior. Once the impact has been determined, the information may be passed to evaluation block **2208** for further processing.

Evaluation block **2208** can marshal the incorrect operation identified in action **2202**, the emergent behavior in action

2204, and the effect on mission in action 2206 to suggest a course of action that the managed entities should adopt, which in the present arrangement is based on a stay-awake signal. The determination of withdrawing or affirming the stay-awake signal can be based on the occurrence of one or more of the identified alarmed conditions, or a combination of two or more of the identified alarmed conditions. For example, the stay-awake signal could be withdrawn if there is emergent behavior and there would be an effect on the mission. In the alternative, the stay-awake signal could be affirmed if there was only emergent behavior, or incorrect operation. Once the evaluation is determined, control can pass to decision block 2402 for further processing in accordance with the decision made in evaluation block 2208.

In action 2402, if the desired control instruction is to maintain the stay-awake signal, control can be passed to action 2302 for further processing. In the alternative, a withdrawal of the stay-awake signal can be sent to action 2306 for further processing. It should be noted that generating a stay-awake signal is equivalent to affirming a stay awake signal, not withdrawing a stay awake signal, or any other condition that can determine if an entity is to perish or to extinguish unless allowed to continue by another entity. The other entity could be a managing entity since it can determine the outcome (life or death) of an entity.

FIG. 25 is a flowchart of a method 2500 for providing security requirements according to an embodiment where a ruler entity decides to withdraw or generate a stay alive signal from an anonymous agent. Method 2500 may solve the need in the art for management of autonomous entities that can be functionally extracted from an environment upon the occurrence of a predetermined condition. Method 2500 may begin with action 2502 where an ALice signal is sent to an anonymous agent to ascertain the agents potential for harm to a system as shown in FIG. 22. After the ALice signal has been sent to the agent, control may be passed to action 2504 for further processing.

In action 2504 the response from the agent may be monitored. Monitored as used herein refers to maintaining regular surveillance, or close observation, over an anonymous agent and can include the absence of a signal. For example, not responding with a timeout period is considered, as used herein, as monitor response. After action 2504 is completed, control may be passed to action 2506 for further processing.

In action 2506, the monitored response from action 2504 may be analyzed to determine if it is in an appropriate format, within a certain timeout period, and with a valid and justified reason for being within the locust of interest or domain of the autonomous system 2204 as shown in FIG. 22. Once the potential for causing harm has been ascertained, control may be passed to action 2508 for further processing.

In action 2508, the system may control the future of the anonymous agent based on the potential for harm to the autonomous system. This mimics the mechanism of cell death in the human (and animal) body, and hence makes use of autonomic and other biologically inspired metaphors. The technique would send self-destruct signals to agents that can be compromised, or which cannot be identified as friendly or as having a right to access certain resources. The concept of the ALice signal is to challenge a mobile agent to determine if it is friendly and has permission to access certain resources. If it fails to identify itself appropriately following an ALice interrogation, it may be blocked from the system and given either a self-destruct signal, or its stay alive reprieve is withdrawn. As an alternative to the ALice signal, a quiesce signal,

command or instruction can be sent. The quiesce signal is discussed in more detail in conduction with FIGS. 10, 23 and 24.

FIG. 26 is a flowchart of a method 2600 of autonomic communication by an autonomic element. Method 2600 may offer a holistic vision for the development and evolution of computer-based systems that brings new levels of automation and dependability to systems, while simultaneously hiding their complexity and reducing their total cost of ownership.

Method 2600 may include transmitting self health/urgency data 2602. Examples of the self health/urgency data may include information describing low battery power and/or failed sensors. Method 2500 may also include transmitting 2604 environment health/urgency data. Examples of the environment health/urgency data may include information describing inaccessible devices, unauthorized access, and/or an unidentified mobile agent sending communication signals.

Transmitting 2602 and 2604 can be performed in any order relative to each other. For example, in one embodiment the transmitting 2602 self health/urgency data may be performed before transmitting 2604 environment health/urgency data. In another embodiment, transmitting 2604 environment health/urgency data may be performed before transmitting 2602 self health/urgency data. In yet another embodiment, the self health/urgency data may be transmitted simultaneously with the environment health/urgency data. For example, the environment health/urgency data and the self health/urgency data may be transmitted together. One example of transmitting the environment health/urgency data and the self health/urgency data may include encapsulating the environment health/urgency data and the self health/urgency data in a X.25 packet, although one skilled in the art will readily recognize that any number of alternative packet types may be used that fall within the scope of this invention. The environment health/urgency data and the self health/urgency data can be thought of together as the "lub-dub" of a heartbeat in which the two "beats" or two pieces of data are transmitted simultaneously. The X.25 standard is published by the ITU Telecommunication Standardization Sector at Place des Nations, CH-1211 Geneva 20, Switzerland.

An autonomic environment may require that autonomic elements and, in particular, autonomic managers communicate with one another concerning self-*activities, in order to ensure the robustness of the environment. A reflex signal 1920 of FIG. 19 above can be facilitated through the pulse monitor (PBM). A PBM can be an extension of the embedded system's heart-beat monitor, or HBM, which safeguards vital processes through the emission of a regular "I am alive" signal to another process with the capability to encode self health/urgency data and environment health/urgency data as a single pulse. HBM is described in greater detail in FIGS. 13, 14 and 21 above. Together with the standard event messages on an autonomic communications channel, this may provide dynamics within autonomic responses and multiple loops of control, such as reflex reactions among the autonomic managers. Some embodiments of the autonomic manager communications (AM/AM) component 1918 may produce a reflex signal 1920 that includes the self health/urgency data and the environment health/urgency data in addition to the HBM. More concisely, the reflex signal can carry a PBM. A reflex signal that carries a PBM can be used to safe-guard the autonomic element by communicating health of the autonomic element to another autonomic unit. For instance, in the situation where each PC in a LAN is equipped with an autonomic manager, rather than each of the individual PCs monitoring the same environment, a few PCs (likely the least busy

machines) can take on this role and alert the others through a change in pulse to indicate changing circumstances.

An important aspect concerning the reflex reaction and the pulse monitor is the minimization of data sent—essentially only a “signal” is transmitted. Strictly speaking, this is not mandatory; more information can be sent, yet the additional information should not compromise the reflex reaction.

Just as the beat of the heart has a double beat (lub-dub), the autonomic element’s pulse monitor can have a double beat encoded—as described above, a self health/urgency measure and an environment health/urgency measure. These match directly with the two control loops within the AE, and the self-awareness and environment awareness properties.

FIG. 27 is a flowchart of a method 2700 of autonomic communication by an autonomic element. Method 2700 may include transmitting 2702 event message data in addition to the self and environment health/urgency data. Event message data can include data describing a change in condition, or a deviation from a normal operation. Event message data is described in more detail above in FIG. 14.

In some embodiments, the self health/urgency data and environment health/urgency data encoded with the standard event messages on an autonomic communications channel, may provide dynamics within autonomic responses and multiple loops of control, such as reflex reactions among an autonomic manager.

FIG. 28 is a flowchart of a method 2800 of autonomic communication by an autonomic element. Method 2800 may include receiving 2802 the self health/urgency data from a self control loop component of the autonomic element. One example of the self control loop component of the autonomic element may be the self awareness control loop 1914 of the autonomic element 1900 of FIG. 19 above.

Method 2800 may also include receiving 2804 the environment health/urgency data from an environment control loop component of the autonomic element. One example of the environment control loop component of the autonomic element may be the environment awareness control loop 1908 of the autonomic element 1900 of FIG. 19 above.

FIG. 29 is a flowchart of a method 2900 of autonomic communication by an autonomic element. Method 2900 may offer a holistic vision for the development and evolution of computer-based systems that brings new levels of automation and dependability to systems, while simultaneously hiding their complexity and reducing processing delays by systems that receive data from the autonomic element.

Method 2900 may include transmitting uncompressed self health/urgency data 2902. Method 2500 may also include transmitting 2904 uncompressed environment health/urgency data. In the absence of bandwidth concerns, the uncompressed data can be acted upon quickly and not incur processing delays. One important aspect may be that the data, whether uncompressed or sent in some other form, should be in a form that can be acted upon immediately and not involve processing delays (such as is the case of event correlation). Transmitting 2902 and 2904 can be performed in any order relative to each other.

CONCLUSION

A quiesce component of an autonomic unit can render the autonomic unit inactive for a specific amount of time or until a challenging situation has passed. Self-managing systems, whether viewed from the autonomic computing perspective, or from the perspective of another initiative, can offer a holistic vision for the development and evolution of computer-based systems that aims to bring new levels of automation and

dependability to systems, while simultaneously hiding their complexity and reducing their total cost of ownership.

Although specific embodiments have been illustrated and described herein, it will be appreciated by those of ordinary skill in the art that any arrangement which is calculated to achieve the same purpose may be substituted for the specific embodiments shown. This application is intended to cover any adaptations or variations. For example, although described in procedural terms, one of ordinary skill in the art will appreciate that implementations can be made in an object-oriented design environment or any other design environment that provides the required relationships.

In particular, one of skill in the art will readily appreciate that the names of the methods and apparatus are not intended to limit embodiments. Furthermore, additional methods and apparatus can be added to the components, functions can be rearranged among the components, and new components to correspond to future enhancements and physical devices used in embodiments can be introduced without departing from the scope of embodiments. One of skill in the art will readily recognize that embodiments are applicable to future communication devices, different file systems, and new data types.

The terminology used in this application is meant to include all environments and alternate technologies which provide the same functionality as described herein.

We claim:

1. A computer-accessible medium in a first autonomic element, the computer-accessible medium having executable instructions of autonomic communication for directing a processor of the first autonomic element to perform:

receiving a quiesce instruction from a second autonomic element; and

invoking a function of a quiesce component of the first autonomic element, and then, if the first autonomic element does not receive a stay-alive reprieve signal after a predetermined period of time, the first autonomic element self-destructs.

2. The computer-accessible medium of claim 1, wherein the function of the quiesce component comprises deactivating the autonomic element.

3. The computer-accessible medium of claim 1, the instructions further directing a processor to perform:

transmitting self health/urgency data, and
transmitting environment health/urgency data.

4. The computer-accessible medium of claim 3, wherein transmitting environment health/urgency data is performed before transmitting self health/urgency data.

5. The computer accessible medium of claim 3, wherein transmitting self health/urgency data is performed before transmitting environment health/urgency data.

6. The computer-accessible medium of claim 3, wherein transmitting environment health/urgency data is performed simultaneously with transmitting self health/urgency data.

7. The computer-accessible medium of claim 6, the instructions further comprising encapsulating the environment health/urgency data and the self health/urgency data in a packet.

8. The computer-accessible medium of claim 3, the instructions further directing a processor to perform:

receiving the self health/urgency data from a self control loop component of the autonomic element.

9. The computer-accessible medium of claim 3 the instructions further directing a processor to perform:

receiving the environment health/urgency data from an environment control loop component of the autonomic element.

10. An autonomic element, the autonomic element comprising:

a self-monitor, the self-monitor receiving information from sensors, monitoring and analyzing the sensor information, and accessing a knowledge repository;

a self-adjuster, operably coupled to the self-monitor in a self control loop, the self adjuster accessing the knowledge repository, transmitting data to effectors, planning and executing;

an environment-monitor, the environment-monitor receiving information from the sensors, monitoring and analyzing the sensor information, and accessing the knowledge repository;

an autonomic manager communications component, operably coupled to the environment-monitor in an environment control loop, the autonomic manager communications component accessing the knowledge repository and producing and transmitting a pulse monitor signal, the pulse monitor signal including a heart beat monitor signal and a reflex signal, the reflex signal including self health/urgency data and environment health/urgency data; and

a quiescing component, operably coupled to the self-monitor, the quiescing component receiving a quiescing instruction from another autonomic element, the quiescing component withdrawing a stay-awake signal, and then, if the autonomic element does not receive a reprieve signal after a predetermined period of time, the autonomic element self-destructs.

11. The autonomic element of claim 10, wherein the self health/urgency data further comprises uncompressed self health/urgency data, and wherein the environment health/urgency data further comprises uncompressed environment health/urgency data.

12. The autonomic element of claim 10, wherein the autonomic manager communications component transmits the environment health/urgency data and the self health/urgency data together.

13. The autonomic element of claim 12, wherein the autonomic manager communications component encapsulates the environment health/urgency data and the self health/urgency data in a packet.

14. The autonomic element of claim 10, wherein the pulse monitor signal further comprises at least one of an urgency signal, environmental condition, and an event condition.

15. A computer-accessible medium having executable instructions to construct an environment to satisfy increasingly demanding external requirements, the executable instructions capable of directing a processor to perform:

instantiating a first embryonic evolvable neural interface; and

evolving the first embryonic evolvable neural interface towards complex connectivity,

wherein the evolvable neural interface receives one or more heart beat monitor signal, pulse monitor signal, and quiesce signals,

wherein the evolvable neural interface generates one or more heart beat monitor signal, pulse monitor signal, and quiesce signals, and

wherein the first evolvable neural interface receives a quiesce signal from a second evolvable neural interface, and then, if the first evolvable neural interface does not

receive a stay-alive reprieve signal after a predetermined period of time, the first evolvable neural interface self-destructs.

16. The computer-accessible medium of claim 15, wherein the embryonic evolvable neural interface further comprises a neural thread possessing only a primitive and minimal connectivity.

17. The computer-accessible medium of claim 15, wherein the quiesce signal further comprises a stay-alive/stay-awake signal.

18. A method for protecting an autonomic system when encountering one or more autonomic agents, the method comprising:

determining the potential harm of the one or more autonomic agent;

sending a quiesce signal to the one or more autonomic agent; and

monitoring the response of the one or more autonomic agent to the quiesce signal, and then, if the autonomic agent does not receive a stay-alive reprieve signal after a predetermined period of time, the autonomic agent self-destructs.

19. The method of claim 18, the method further comprising:

controlling the autonomic system based on the autonomic agent potential for causing harm to the autonomic system.

20. The method of claim 19, wherein controlling the autonomic system further comprises generating a signal to the autonomic agent to withdraw the autonomic agent stay-alive/stay-awake signal.

21. A computer-accessible medium having executable instructions to protect an autonomic system when encountering one or more autonomic agent, the executable instructions capable of directing a processor of an autonomic agent to perform:

sending a quiesce signal to the autonomic agent; monitoring the response of the autonomic agent to the quiesce signal; and

determining the autonomic agent potential for causing harm to the autonomic system, and then, if the autonomic agent does not receive a stay-alive reprieve signal after a predetermined period of time, the autonomic agent self-destruct.

22. The computer-accessible medium of claim 21, the computer-accessible medium further comprising:

controlling the autonomic system based on the autonomic agent potential for causing harm to the autonomic system, wherein a quiesce signal is a request for the autonomic agent to deactivate.

23. The computer-accessible medium of claim 22, wherein controlling the autonomic system further comprises blocking the autonomic agent from accessing certain resources; and

generating a signal to the autonomic agent to transmit the autonomic agent stay-alive/stay-awake.

24. The computer-accessible medium of claim 23, wherein controlling the autonomic system further comprises generating a signal to the autonomic agent to withdraw the autonomic agent stay-alive/stay-awake.